

Please check the examination details below before entering your candidate information

Candidate surname					Other names							
Pearson Edexcel					Centre Number				Candidate Number			
Level 1/Level 2 GCSE (9–1)					<input type="text"/> <input type="text"/> <input type="text"/> <input type="text"/> <input type="text"/>				<input type="text"/> <input type="text"/> <input type="text"/> <input type="text"/>			
Time 1 hour 45 minutes					Paper reference		1 BI0/1F					
Biology											▲ ▲	
PAPER 1												
											Foundation Tier	
You must have: Calculator, ruler										Total Marks		

Instructions

- Use **black** ink or ball-point pen.
- **Fill in the boxes** at the top of this page with your name, centre number and candidate number.
- Answer **all** questions.
- Answer the questions in the spaces provided – *there may be more space than you need.*
- Any diagrams may NOT be accurately drawn, unless otherwise indicated.
- You must **show all your working out** with **your answer clearly identified** at the **end of your solution**.

Information

- The total mark for this paper is 100.
- The marks for **each** question are shown in brackets – *use this as a guide as to how much time to spend on each question.*
- In questions marked with an **asterisk (*)**, marks will be awarded for your ability to structure your answer logically showing how the points that you make are related or follow on from each other where appropriate.
- Calculators may be used.

Advice

- Read each question carefully before you start to answer it.
- Try to answer every question.
- Check your answers if you have time at the end.
- Good luck with your examination.

Turn over ►



Answer ALL questions. Write your answers in the spaces provided.

Some questions must be answered with a cross in a box ☒. If you change your mind about an answer, put a line through the box ☒ and then mark your new answer with a cross ☒.

1 (a) Animals and plants are made of cells.

Figure 1 shows two types of cell from a human.

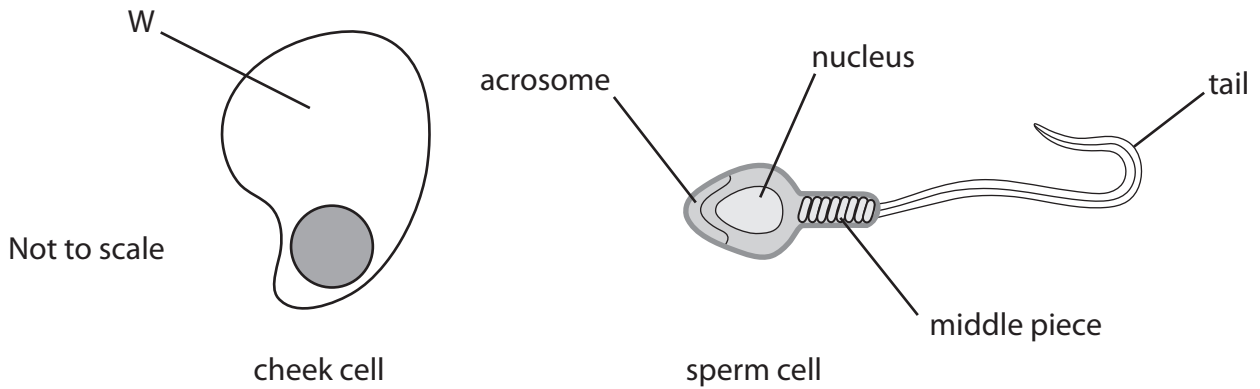

Figure 1

(i) Which part of the cheek cell is labelled W?

(1)

- A cell wall
- B nucleus
- C cell membrane
- D cytoplasm

(ii) Which labelled part of the sperm cell is also found in the cheek cell?

(1)

- A nucleus
- B tail
- C middle piece
- D acrosome

(b) Name the part of a plant cell that gives the cell support and protection.

(1)



(c) Some cells contain starch.

Describe the chemical test for starch.

(2)

.....

.....

.....

.....

(d) Figure 2 shows the results of some food tests.

food sample	Benedict's test	Biuret test	ethanol (alcohol) test
J	brick red	blue	colourless
K	brick red	purple	colourless
L	blue	blue	white emulsion

Figure 2

(i) Give the letter of the food sample that contains fat.

(1)

.....

(ii) Give the letter of the food sample that contains reducing sugars and protein.

(1)

.....

(Total for Question 1 = 7 marks)

.....



2 Figure 3 shows a cell from an onion root tip.

This cell is dividing by mitosis.

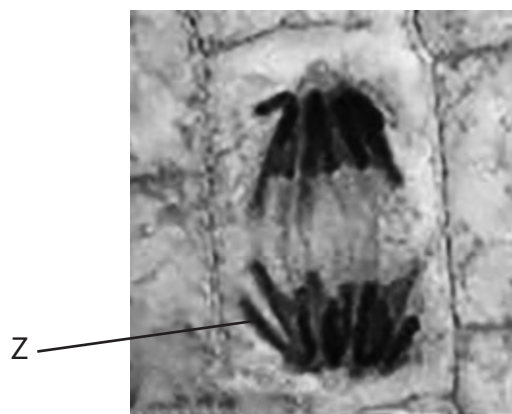

Figure 3

(a) (i) Which structure is labelled Z?

(1)

- A allele
- B chromosome
- C spindle
- D nuclear membrane

(ii) Mitosis produces new cells.

Give **two** reasons why mitosis is important in living things.

(2)

1

2



(iii) Draw **one** straight line from each stage of the cell cycle to its description.

(2)

stage of cell cycle

description

interphase	the nuclear membrane breaks down
cytokinesis	two nuclei are formed
	the cell divides in two
	a spindle is formed
	DNA is copied

(b) A student is preparing a microscope slide of plant cells.

(i) State what can be added to the slide to make the plant cells more visible.

(1)

(ii) The microscope has two lenses:

- an eyepiece lens with $\times 10$ magnification
- an objective lens with $\times 40$ magnification

Which is the **total** magnification of this microscope?

(1)

- A** $\times 4$
- B** $\times 30$
- C** $\times 50$
- D** $\times 400$

(c) Name **one** part of a light microscope that can be moved to obtain a clear image of plant cells.

(1)

(Total for Question 2 = 8 marks)



3 (a) Sickle cell disease is a recessive genetic disorder in humans.

(i) Two parents are heterozygous for sickle cell disease.

Complete the Punnett square to show the possible genotypes of their children.

(1)

	D	d
D		
d		

(ii) State the percentage probability that their children could have sickle cell disease.

(1)

percentage probability = %

(iii) A father with the genotype dd and a mother with the genotype DD plan to have several children.

Explain why none of their children will have sickle cell disease.

(2)

.....

.....

.....

.....

.....

.....



DO NOT WRITE IN THIS AREA

DO NOT WRITE IN THIS AREA

DO NOT WRITE IN THIS AREA

(b) Figure 4 shows some information about two types of cattle.

type of cattle	survival in high temperatures	meat quality
Brahman	good	poor
Shorthorn	poor	good

Figure 4

Describe how these types of cattle could be selectively bred to produce cattle that can survive high temperatures and have good meat quality.

(2)

.....

.....

.....

.....

.....

.....

.....

.....



(c) Figure 5 shows the leaf of a wheat plant with a fungal disease.

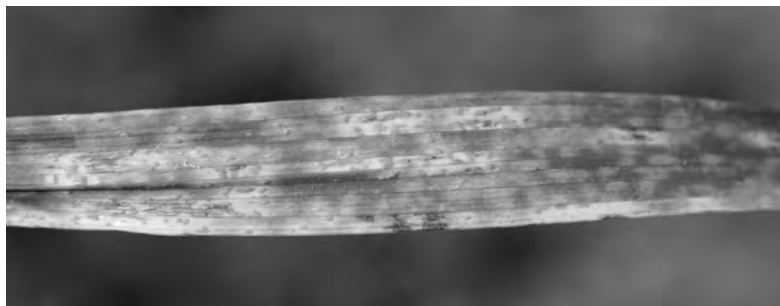

(Source: © Kazakov Maksim/Shutterstock)

Figure 5

Give **two** benefits of breeding wheat plants that are resistant to fungal disease. (2)

- 1
- 2

(Total for Question 3 = 8 marks)



DO NOT WRITE IN THIS AREA

DO NOT WRITE IN THIS AREA

DO NOT WRITE IN THIS AREA

BLANK PAGE



- 4 (a) A calorimeter can be used to measure the energy content of food.

Figure 6 shows a simple calorimeter.

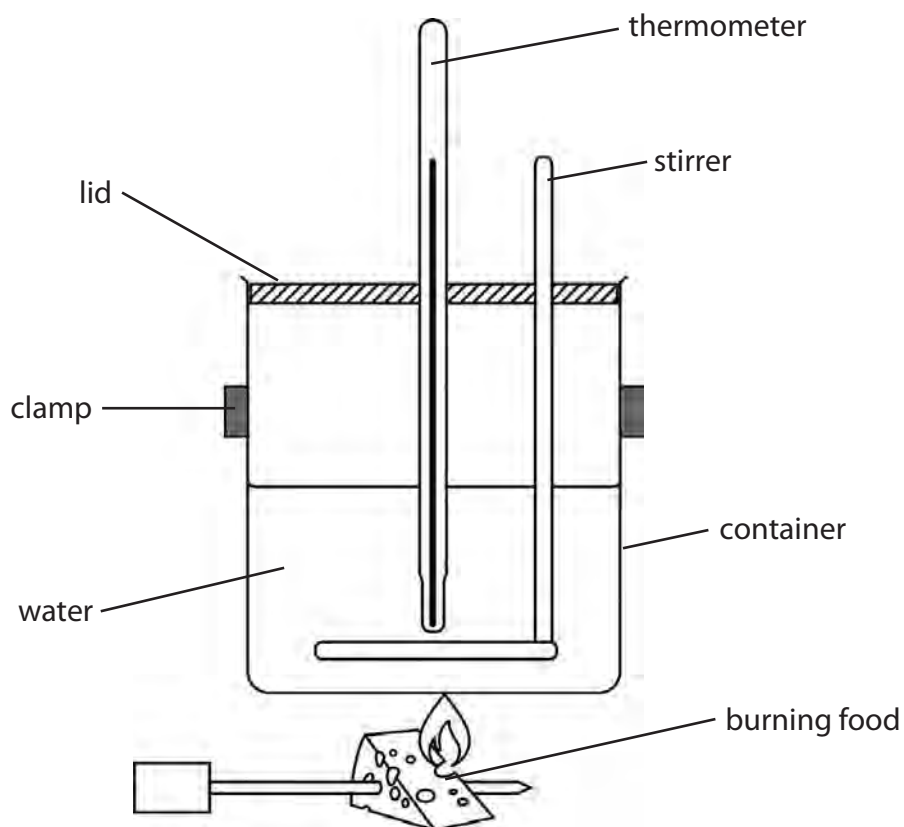

Figure 6

- (i) Use words from the box to complete the sentences.

(2)

air

clamp

food

lid

thermometer

water.

The stirrer distributes heat evenly in the

The calorimeter has a to prevent the loss of heat.



(ii) This calorimeter was used to measure the energy content of a piece of cheese.

Figure 7 shows some of the results.

mass of water in grams	starting temperature of water in °C	final temperature of water in °C
25	21	85

Figure 7

Calculate the energy content of this piece of cheese.

(2)

Use the equation

$$\text{energy in joules (J)} = \text{mass of water} \times 4.2 \times \text{temperature change}$$

energy content of the piece of cheese = J

(iii) The same method was used to calculate the energy content of a different type of cheese.

The results are shown in Figure 8.

mass of water in grams	starting temperature of water in °C	final temperature of water in °C	temperature change in °C
25	21	76	55

Figure 8

Explain **one** reason why the results are different for this type of cheese.

(2)

.....

.....

.....

.....

DO NOT WRITE IN THIS AREA

DO NOT WRITE IN THIS AREA

DO NOT WRITE IN THIS AREA



(b) Body mass index (BMI) is calculated using the equation:

$$\text{BMI} = \frac{\text{mass (kg)}}{(\text{height (m)})^2}$$

(i) Person A is 1.8 m tall and has a mass of 64.8 kg.

Calculate the BMI of person A.

(2)

BMI =

(ii) Figure 9 shows some information about BMI.

BMI	BMI category
less than 18.5	underweight
18.5 to 24.9	healthy weight
25 to 29.9	overweight
more than 29.9	obese

Figure 9

Person B has a BMI of 18.5.

Which category is correct for person B?

(1)

- A** underweight
- B** healthy weight
- C** overweight
- D** obese



(iii) Person C has a BMI of 28.5.

Explain **one** way person C could change their lifestyle to reach a healthy weight.

(2)

.....

.....

.....

.....

(Total for Question 4 = 11 marks)

DO NOT WRITE IN THIS AREA

DO NOT WRITE IN THIS AREA

DO NOT WRITE IN THIS AREA



5 (a) Carrots have different physical characteristics such as colour.

Which genetic term describes the physical characteristics of a carrot?

(1)

- A genotype
- B monohybrid
- C phenotype
- D heterozygous

(b) Figure 10 shows some carrot sticks.

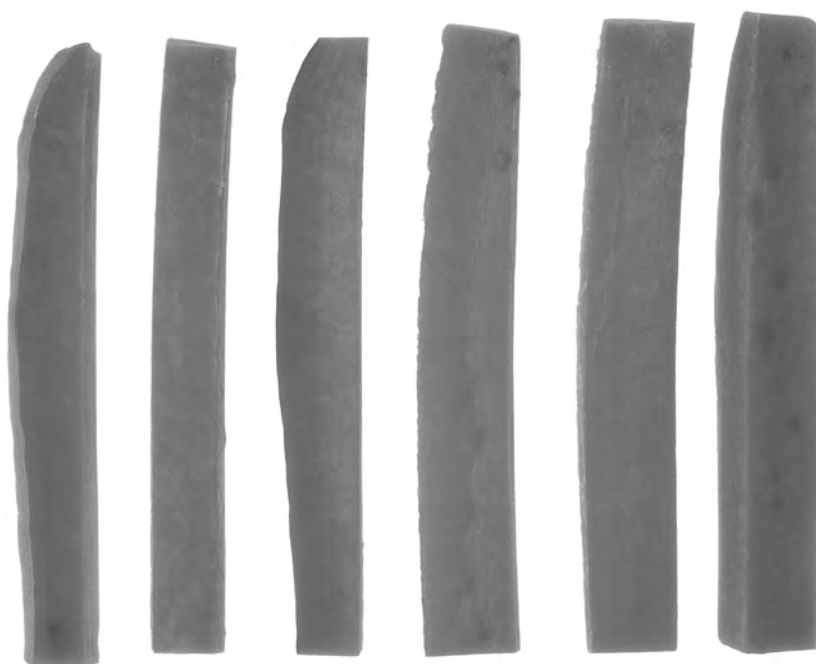

(Source: © rukxstockphoto/Shutterstock)

Figure 10

A student chose three carrot sticks and weighed each one.

The carrot sticks were placed in 50 cm³ of distilled water.

After two hours the student weighed each carrot stick again.

Figure 11 shows the results for these carrot sticks P, Q and R.

carrot stick	mass at the start in grams	mass after two hours in grams	change in mass in grams
P	4.0	4.9	0.9
Q	4.2	5.0	0.8
R	4.1	5.0	0.9

Figure 11



(i) Give **one** reason why the student used three carrot sticks instead of just one carrot stick.

(1)

(ii) Give **two** ways that this method could be improved.

(2)

1

2

(iii) Calculate the percentage change in mass of carrot stick **Q**.

(3)

Use the equation

$$\text{percentage change} = \frac{\text{change in mass}}{\text{mass at the start}} \times 100$$

Give your answer to 2 significant figures.

percentage change = %

DO NOT WRITE IN THIS AREA

DO NOT WRITE IN THIS AREA

DO NOT WRITE IN THIS AREA



(iv) Explain the change in mass of the carrot sticks.

(2)

.....

.....

.....

.....

(Total for Question 5 = 9 marks)

DO NOT WRITE IN THIS AREA

DO NOT WRITE IN THIS AREA

DO NOT WRITE IN THIS AREA



6 (a) Why are enzymes called biological catalysts?

(1)

- A because they slow down biological processes
- B because they speed up biological processes
- C because they denature biological processes
- D because they stop biological processes

(b) Many cells contain an enzyme called catalase.

Catalase breaks down hydrogen peroxide into water and oxygen.

A scientist investigated the effect of hydrogen peroxide concentration on the time taken to produce 20 cm^3 of oxygen.

Figure 12 shows the equipment used.

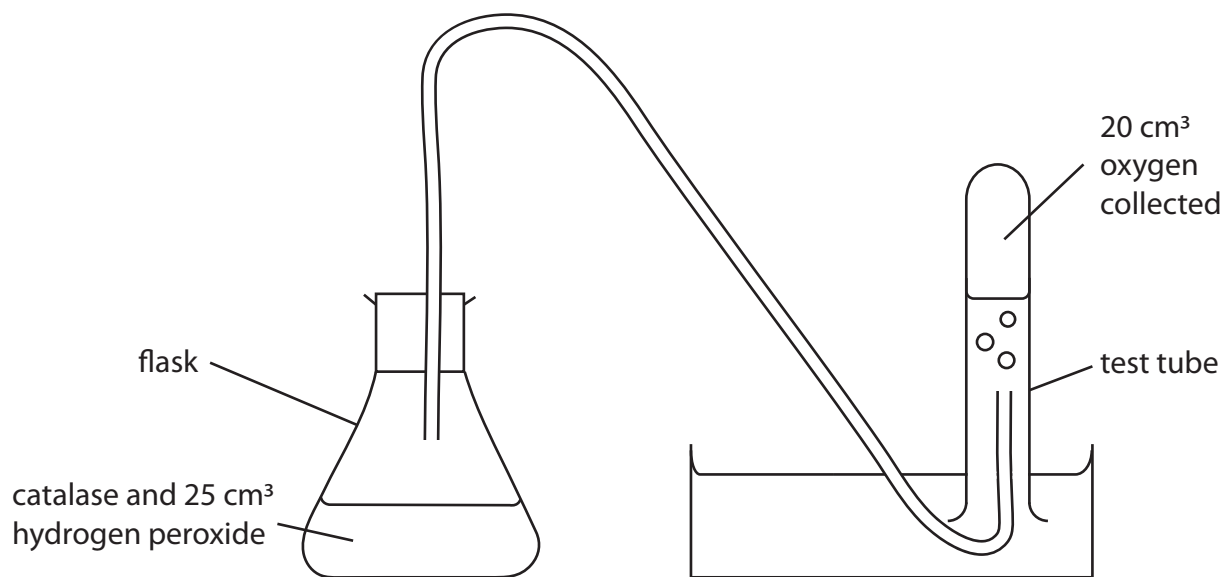

Figure 12

(i) State how the scientist could control the temperature of the flask.

(1)



(ii) Explain why the temperature should be controlled in this investigation.

(3)

.....

.....

.....

.....

.....

.....

(iii) This investigation used five different concentrations of hydrogen peroxide.

Figure 13 shows the results of this investigation.

concentration of hydrogen peroxide in arbitrary units	time taken to collect 20 cm ³ of oxygen in seconds
4	32
8	14
12	9
16	7
20	6

Figure 13

DO NOT WRITE IN THIS AREA

DO NOT WRITE IN THIS AREA

DO NOT WRITE IN THIS AREA



Complete the graph by plotting the points and drawing a line to show the trend in the data.

The first point has been plotted for you.

(2)

time taken to
collect 20 cm³
of oxygen
in seconds

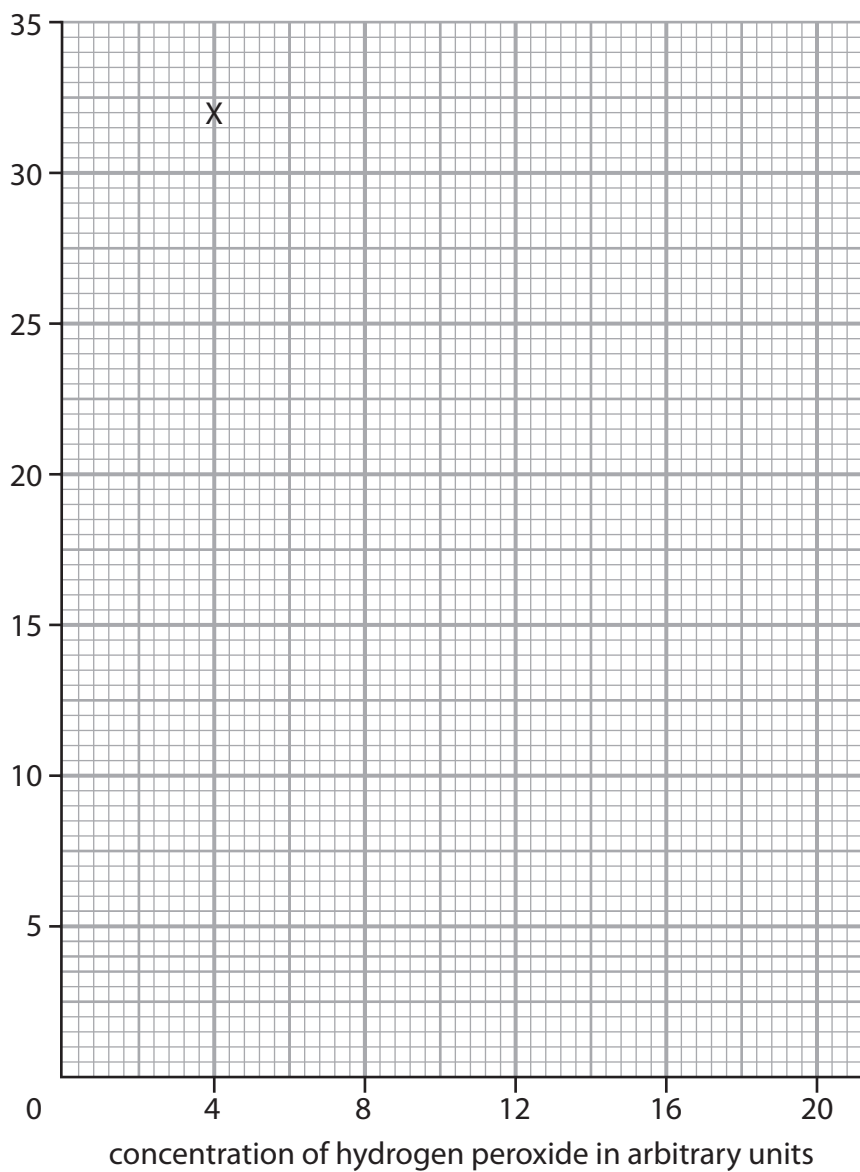

DO NOT WRITE IN THIS AREA

DO NOT WRITE IN THIS AREA

DO NOT WRITE IN THIS AREA



(iv) Describe the trend shown in the graph.

Use data from the table in Figure 13 to support your answer.

(3)

.....

.....

.....

.....

.....

.....

(Total for Question 6 = 10 marks)

DO NOT WRITE IN THIS AREA

DO NOT WRITE IN THIS AREA

DO NOT WRITE IN THIS AREA



DO NOT WRITE IN THIS AREA

DO NOT WRITE IN THIS AREA

DO NOT WRITE IN THIS AREA

7 (a) Figure 14 shows the limbs of some animals.

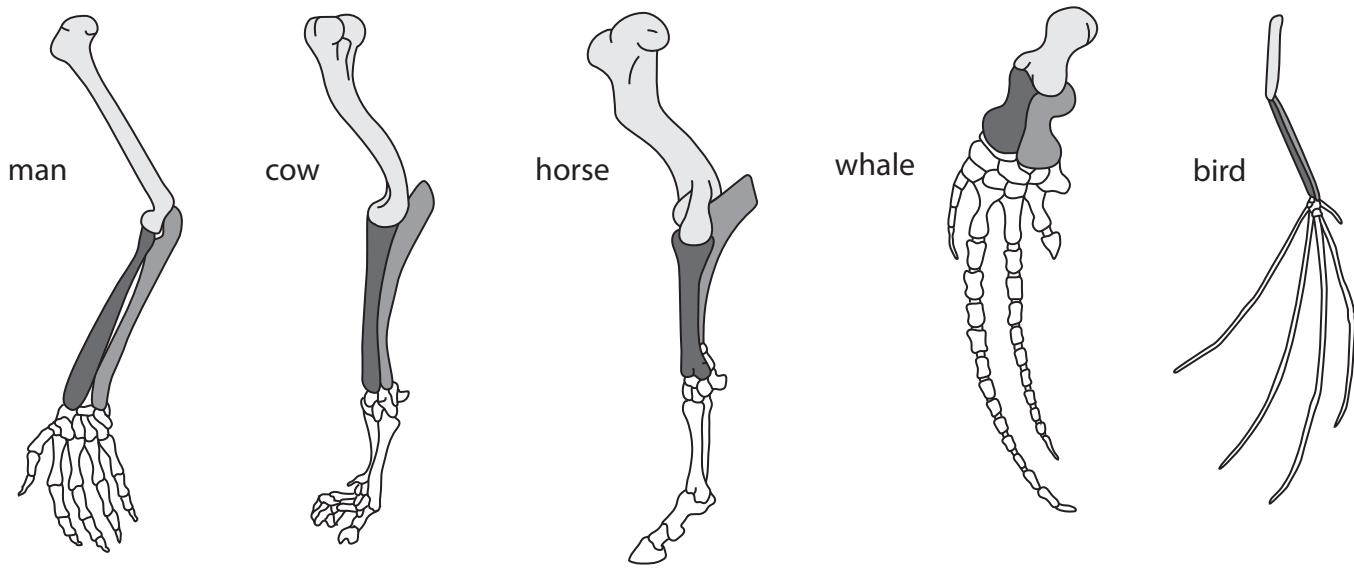

Figure 14

Describe how these limbs provide evidence for evolution.

(2)

.....

.....

.....

.....

.....



(b) Prickly pear cacti are weeds that grow in many countries.

Insects have been used to limit the population of prickly pear cacti.

Figure 15 shows some insects on a prickly pear cactus.



(Source: © Catherine Eckert/Shutterstock)

Figure 15

(i) Which is the name of this method of limiting the population of weeds?

(1)

- A** biological control
- B** chemical control
- C** tissue culture
- D** genetic engineering

(ii) Give **two** benefits of using insects, rather than chemicals, on prickly pear cacti.

(2)

1

2



8 (a) Motor neurones are found in the nervous system.

Figure 16 shows a motor neurone.

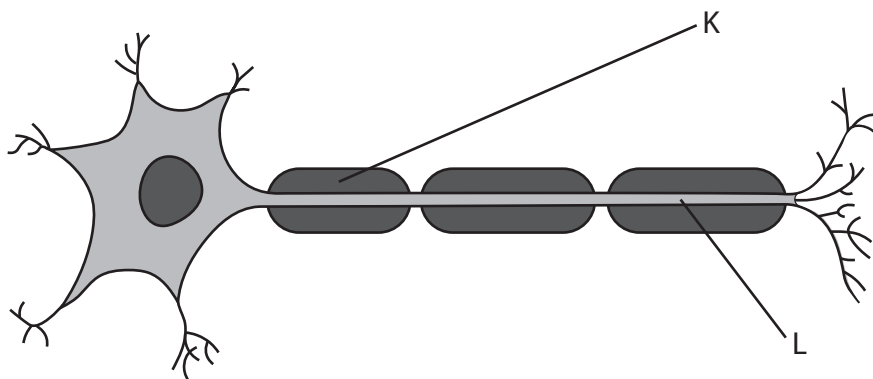

Figure 16

(i) Draw an arrow on Figure 16 to show the direction of travel of an electrical impulse along the motor neurone.

(1)

(ii) Name both structure **K** and structure **L**.

(2)

K

L

DO NOT WRITE IN THIS AREA

DO NOT WRITE IN THIS AREA

DO NOT WRITE IN THIS AREA



(b) Figure 17 shows part of a reflex arc in the spinal cord.

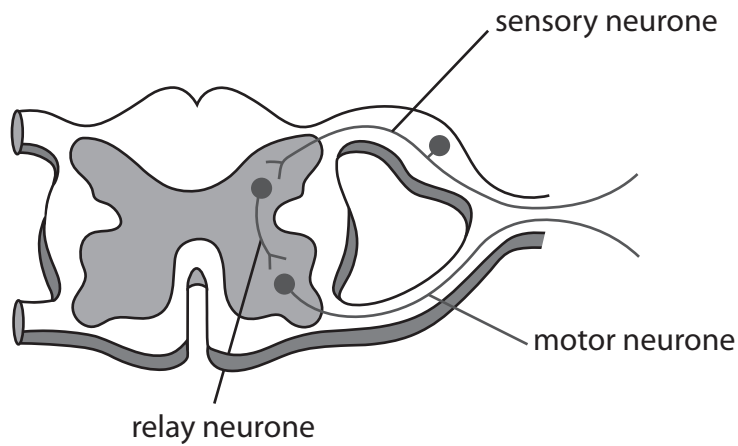

Figure 17

(i) Describe how an impulse passes from the relay neurone to the motor neurone.

(3)

.....

.....

.....

.....

.....

.....

.....

(ii) Explain the function of a reflex arc.

(2)

.....

.....

.....

.....

.....



- (c) A scientist investigated the reaction times of five students using a computer program.

The computer screen showed a blue square at the start.

As soon as the blue square turned yellow, each student had to press a key on the keyboard as fast as possible.

Figure 18 shows the results for the five students.

student	reaction time in milliseconds
1	245
2	200
3	210
4	215
5	225

Figure 18

- (i) Which is the median result for these students?

(1)

- A** 200 milliseconds
- B** 210 milliseconds
- C** 215 milliseconds
- D** 225 milliseconds



- (ii) The scientist wanted to investigate if the colours of the squares used on the computer program affected reaction time.

The computer program started with blue squares that turned into yellow squares.

Describe how the scientist could compare the reaction times of these students when they respond to red squares turning into yellow squares.

(3)

.....

.....

.....

.....

.....

.....

.....

(Total for Question 8 = 12 marks)

DO NOT WRITE IN THIS AREA

DO NOT WRITE IN THIS AREA

DO NOT WRITE IN THIS AREA



9 (a) Name the organisation which defines health as a state of complete physical, mental and social well-being and not merely the absence of disease or infirmity. (1)

.....

(b) Tuberculosis (TB) is a communicable disease.

(i) State **two** ways that communicable diseases are different from non-communicable diseases. (2)

1

.....

2

.....

(ii) Explain **one** way that the spread of tuberculosis (TB) can be reduced or prevented. (2)

.....

.....

.....

.....



(iii) A student researched the number of people with TB in some countries.

Figure 19 shows the student's data.

	<i>Belgium 1000</i>	<i>Portugal 2400</i>
	<i>UK 5400 people</i>	
	<i>Germany 6100</i>	<i>5800 in France</i>

Figure 19

Complete the table to show the student's data.

(2)

DO NOT WRITE IN THIS AREA

DO NOT WRITE IN THIS AREA

DO NOT WRITE IN THIS AREA



10 *Streptococcus mutans* is one species of bacteria which causes tooth decay.

A scientist tested the effectiveness of toothpaste at killing this species of bacteria.

The scientist spread the bacteria *Streptococcus mutans* across an agar jelly plate.

(a) (i) Which word describes the techniques used to prevent contamination of the agar jelly plate?

(1)

- A clinical
- B diagnostic
- C aseptic
- D lysogenic

(ii) Give **two** precautions needed to prevent contamination of the agar jelly plate.

(2)

1

.....

2

.....



- (b) The scientist placed a filter paper disc soaked in toothpaste mixed with saliva (disc A) on one half of the agar jelly plate.

A filter paper disc soaked in only saliva (disc B) was placed on the other half of the agar jelly plate.

The agar jelly plate was kept at 37°C for 24 hours.

Figure 20 shows the results.

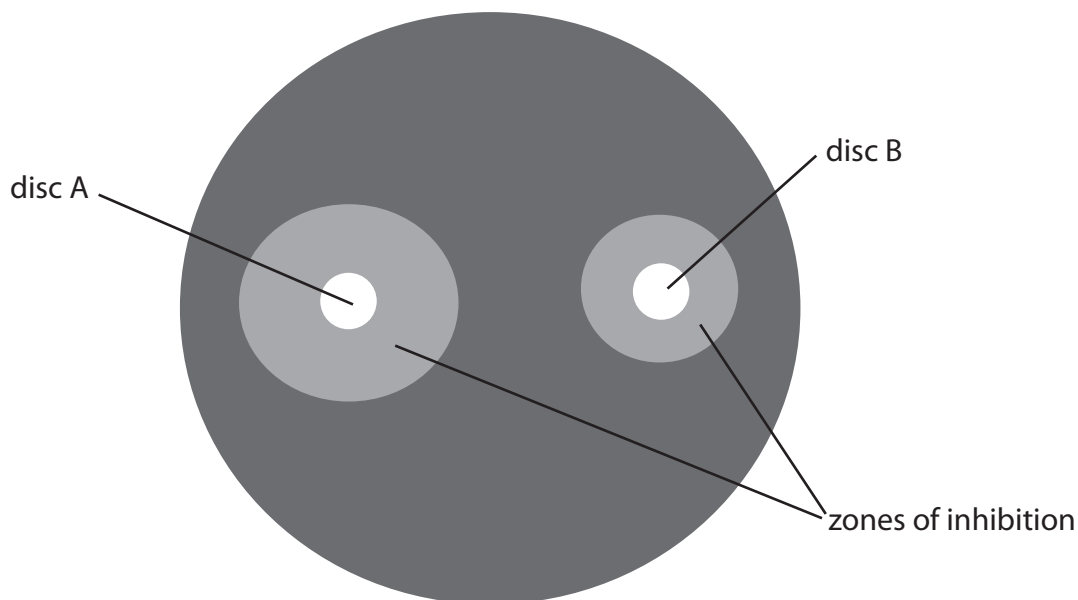

Figure 20

- (i) The diameter of the zone of inhibition around disc A is 9 mm.

Calculate the area of this zone of inhibition using the equation πr^2 .

Use a value of 3.14 for π .

Give your answer to 1 decimal place.

(3)

..... mm²

- (ii) Give a reason why disc B, soaked in only saliva, was included in this test.

(1)



(iii) Suggest **two** reasons why this test does not prove that toothpaste kills all bacteria on teeth.

(2)

1

2

(c) Before a new toothpaste can be sold, the toothpaste has to be tested on cultured human cells.

Cultured human cells were placed into four identical flasks.

Saliva was added to each flask and a different brand of toothpaste was added to each of three flasks.

The human cells were left for two hours and the percentage of cells that were healthy was recorded.

Figure 21 shows the results.

substance added to the human cells	percentage of healthy cells after 2 hours (%)
saliva only	85
toothpaste brand 1	84
toothpaste brand 2	86
toothpaste brand 3	85

Figure 21

Explain the conclusion that can be made from this data.

(2)

.....

.....

.....

.....

(Total for Question 10 = 11 marks)

TOTAL FOR PAPER = 100 MARKS



DO NOT WRITE IN THIS AREA

DO NOT WRITE IN THIS AREA

DO NOT WRITE IN THIS AREA

BLANK PAGE



DO NOT WRITE IN THIS AREA

DO NOT WRITE IN THIS AREA

DO NOT WRITE IN THIS AREA

BLANK PAGE



DO NOT WRITE IN THIS AREA

DO NOT WRITE IN THIS AREA

DO NOT WRITE IN THIS AREA

BLANK PAGE

