

Surname	Centre Number	Candidate Number
Other Names		2



GCE AS – NEW

B420U20-1



PHYSICS – AS component 2
Electricity and Light

THURSDAY, 8 JUNE 2017 – AFTERNOON

1 hour 30 minutes

For Examiner's use only		
Question	Maximum Mark	Mark Awarded
1.	7	
2.	8	
3.	13	
4.	12	
5.	16	
6.	8	
7.	11	
Total	75	

ADDITIONAL MATERIALS

In addition to this paper, you will require a calculator and a **Data Booklet**.

INSTRUCTIONS TO CANDIDATES

Use black ink or black ball-point pen.

Write your name, centre number and candidate number in the spaces at the top of this page.

Answer **all** questions.

Write your answers in the spaces provided in this booklet.

INFORMATION FOR CANDIDATES

The total number of marks available for this paper is 75.

The number of marks is given in brackets at the end of each question or part-question.

You are reminded to show all working. Credit is given for correct working even when the final answer is incorrect.

The assessment of the quality of extended response (QER) will take place in **Q6(a)**.

Answer all questions.

1. The diagram shows a potential difference against time graph detected with a microphone in response to a sound wave.

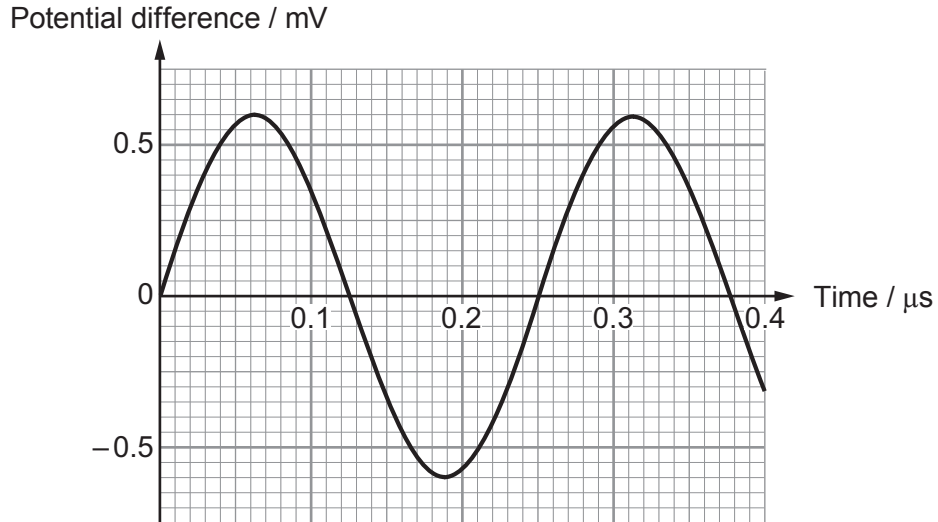

- (a) Sound is a longitudinal wave. State what is meant by a longitudinal wave. [2]

.....

.....

.....

- (b) Determine the amplitude of the signal shown. [1]

.....

- (c) (i) In order to probe muscle tissue in the human body, ultrasound is used with a wavelength of 0.40 mm and a speed in muscle of 1580 m s^{-1} . Calculate the frequency of this ultrasound. [1]

.....

.....

- (ii) Evaluate whether the sound wave detected by the microphone as shown above can be used to probe muscle tissue. [3]

.....

.....

.....

.....

.....

2. The diagram shows a ray of light incident at an angle of 60° to the surface of a layer of oil that is floating on water.

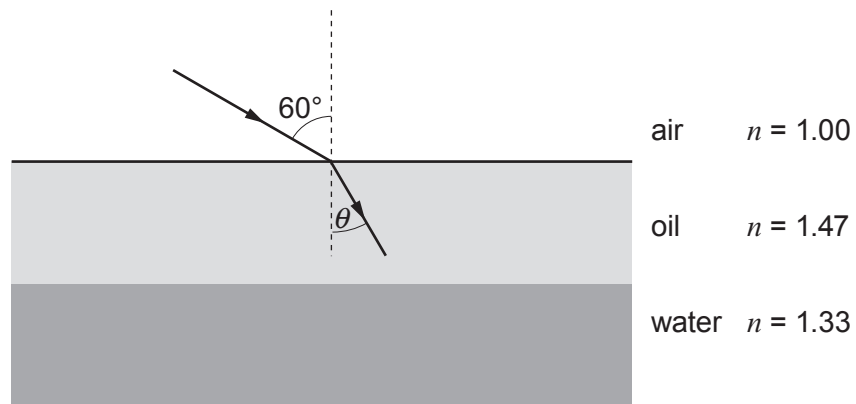

- (a) Calculate the angle of refraction, θ .

[2]

.....

.....

.....

- (b) (i) Calculate the critical angle for a ray of light travelling from oil to water.

[2]

.....

.....

.....

- (ii) State and explain what happens to the ray of light in the diagram above when it reaches the boundary with the water.

[2]

.....

.....

.....

.....

- (c) Determine the speed of the light in the oil.

[2]

.....

.....

.....

.....

3. Abigail investigates how the power dissipated in a variable resistor varies as its resistance is altered. The diagram shows the circuit that Abigail uses (meters not shown). The variable resistor is connected to a battery of emf, E , and internal resistance, r .

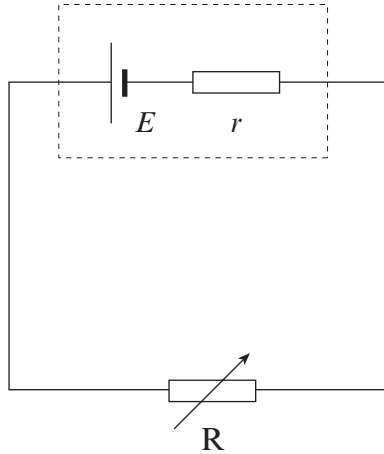

Abigail obtains the following data as the resistance is varied from $0.5\ \Omega$ to $6.0\ \Omega$.

Resistance, R / Ω	Power dissipated in R / W
0.5	2.5
1.0	3.3
2.0	3.8
3.0	3.8
4.0	3.7
5.0	3.6
6.0	3.5

- (a) Plot a graph of power dissipated in R (on the y -axis) against resistance (on the x -axis) and draw a smooth curve through the data. [3]

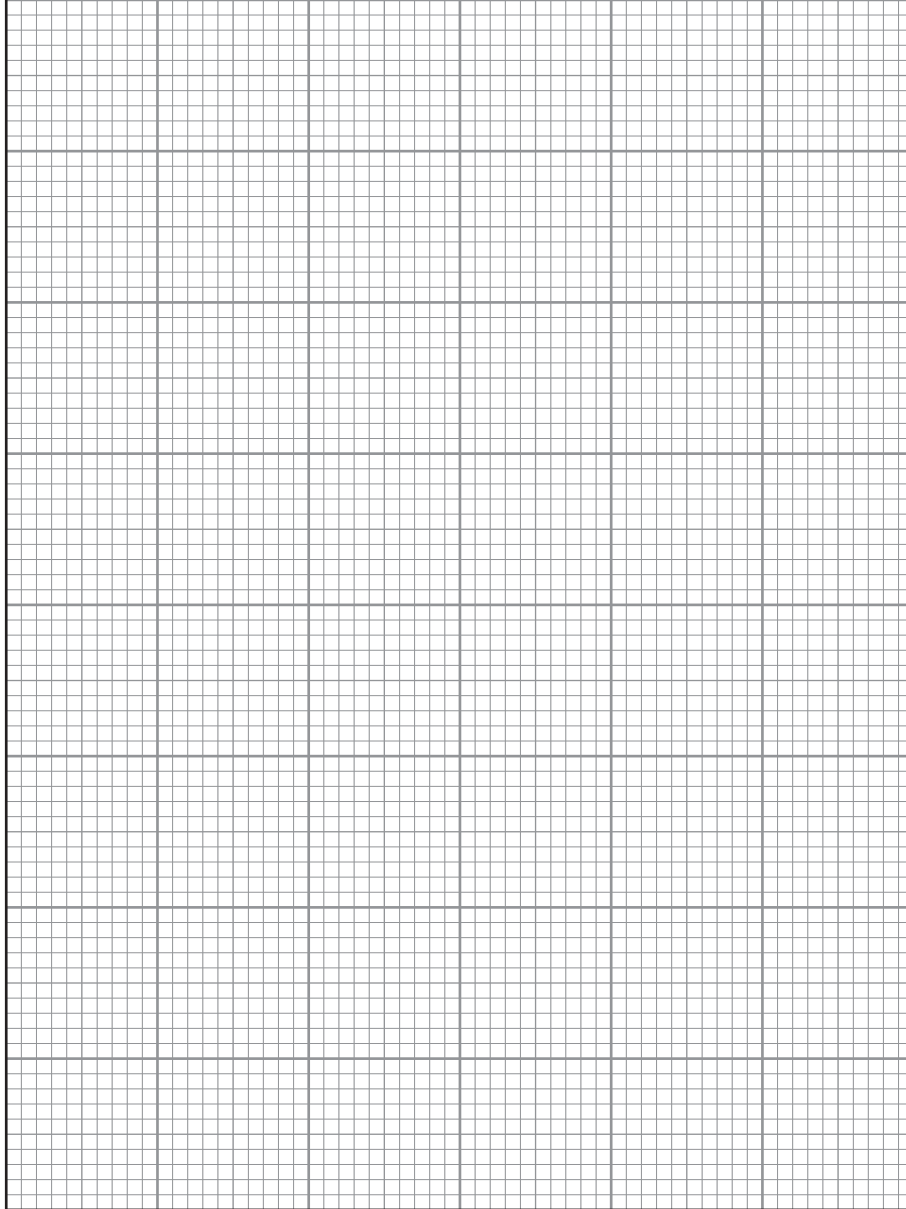

(b) The emf of the battery is 6.0 V and the resistance, R , is now set at $4.5\ \Omega$.

(i) State what is meant by an *emf* of 6.0 V.

[2]

.....

.....

.....

(ii) Calculate the current through the battery using data from your graph.

[3]

.....

.....

.....

.....

(iii) Calculate the internal resistance, r , of the battery.

[3]

.....

.....

.....

.....

.....

.....

(c) Abigail repeats the experiment but with a battery of the same emf but smaller internal resistance. Explain how the graph would change.

[2]

.....

.....

.....

.....

.....

4. (a) Calculate the mean drift velocity of the free electrons in a wire, which has a diameter of 0.50 mm and carries a current of 2.8 A. Assume each aluminium atom contributes 3 free electrons, and there are 6.0×10^{28} atoms per m^3 of aluminium. [4]

.....

.....

.....

.....

.....

.....

- (b) The wire is thinner in a small section as shown below.

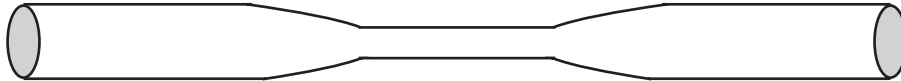

Paula claims that within the thinner section the mean drift velocity of the free electrons will be greater. Evaluate whether she is correct. [3]

.....

.....

.....

.....

.....

- (c) (i) State what is meant by a superconductor. [1]

.....

.....

.....

- (ii) State and explain **one** advantage and **one** disadvantage of using superconductors to carry large currents. [4]

Advantage:.....

.....

.....

Disadvantage:.....

.....

.....

5. The apparatus shown below is used to produce a visible interference pattern on the screen.

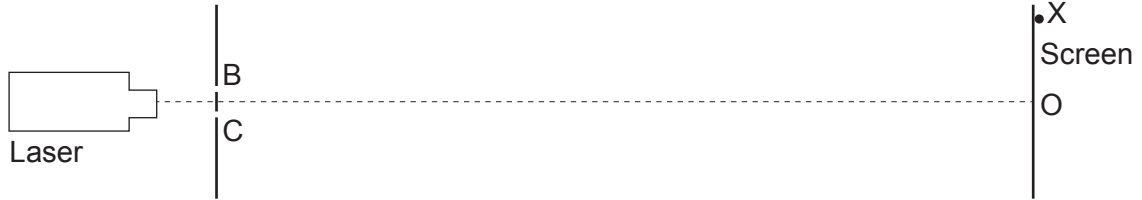

Slits B and C act as *coherent* sources.

(a) (i) Explain what is meant by this statement. [1]

.....

.....

(ii) Explain why destructive interference is observed at certain points on the screen. [3]

.....

.....

.....

.....

(b) (i) The separation of the slits, B and C is 0.090mm and the perpendicular distance between the slits and the screen is 3.60m. The slits are illuminated with light of wavelength 4.4×10^{-7} m. A point X on the screen is 52.8 mm away from the central bright fringe at O. Brian states that a bright fringe will be formed at X. Evaluate whether or not he is correct. [4]

.....

.....

.....

.....

.....

(ii) Determine the distance **from** X to the **next dark** fringe formed. [2]

.....

.....

.....

(c) Explain the historical significance of this experiment. [2]

.....

.....

.....

.....

(d) A beam of electrons is fired at a thin sheet of aluminium. A pattern of light and dark circular fringes is observed as shown below.

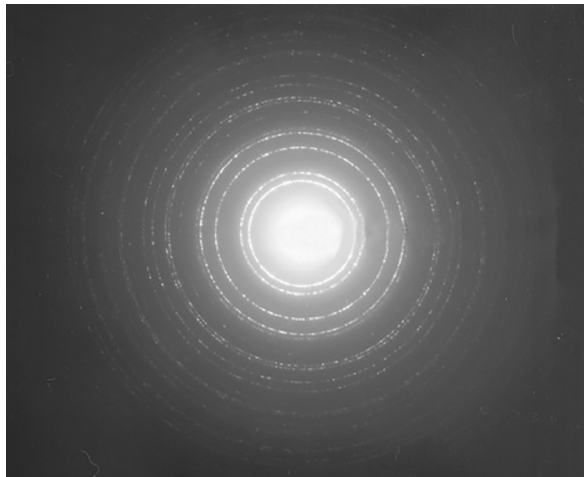

(i) Explain how this pattern is formed. [2]

.....

.....

.....

.....

(ii) The thin sheet of aluminium is replaced with a foil of copper. The distance between the copper atoms is smaller than in aluminium. Describe how you expect the pattern to change. [2]

.....

.....

.....

Examiner
only

6. (a) Describe an experiment using a range of LEDs to determine the Planck constant.

[6 QER]

.....

.....

.....

.....

.....

.....

.....

.....

.....

.....

.....

.....

.....

.....

.....

.....

.....

.....

.....

.....

.....

.....

.....

.....

.....

.....

.....

.....

.....

.....

.....

.....

.....

(b) A university research group uses a new experimental method to determine a value for the Planck constant that is higher than the accepted value of 6.63×10^{-34} Js. Explain how other scientists would attempt to confirm this result. [2]

.....

.....

.....

.....

8

7. When sunlight shines on the atmosphere of Mars, carbon dioxide molecules at a height of 75 km behave like the amplifying medium in a laser. The energy levels involved are shown in the following diagram. A population inversion occurs between energy levels E_1 and E_2 .

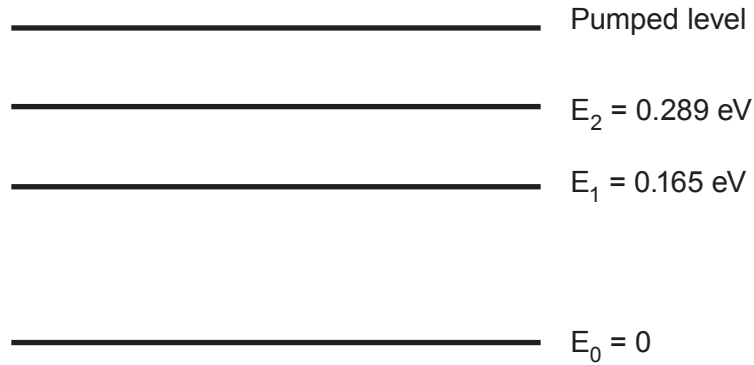

- (a) (i) State what is meant by a population inversion. [1]

.....

.....

.....

- (ii) Explain why a population inversion is needed for laser action. [2]

.....

.....

.....

.....

- (b) Calculate the output wavelength of this naturally occurring laser and determine the region of the electromagnetic spectrum in which it lies. [3]

.....

.....

.....

.....

.....

TURN OVER FOR THE LAST PART OF THE QUESTION

- (c) The Llanesco crater is on the surface of Mars and has a cross-sectional area of 2290 km^2 . Carbon dioxide molecules in the Mars atmosphere collide with the surface and give rise to a surface pressure of 600 Pa . The mass of a carbon dioxide molecule is $7.3 \times 10^{-26} \text{ kg}$ and the perpendicular component of the speed of the molecules to the surface is 550 ms^{-1} **before** and **after** they collide with the surface. Calculate the number of carbon dioxide molecules that collide with the Llanesco crater in 1 s. [5]

.....

.....

.....

.....

.....

.....

.....

.....

END OF PAPER