



Oxford Cambridge and RSA

**Friday 16 October 2020 – Morning**

**AS Level Biology A**

**H020/02** Depth in biology

**Time allowed: 1 hour 30 minutes**



**You must have:**

- the Insert (inside this document)

**You can use:**

- a scientific or graphical calculator
- a ruler (cm/mm)



Please write clearly in black ink. **Do not write in the barcodes.**

Centre number

--	--	--	--	--

Candidate number

--	--	--	--

First name(s)

---

Last name

---

**INSTRUCTIONS**

- Use black ink. You can use an HB pencil, but only for graphs and diagrams.
- Write your answer to each question in the space provided. If you need extra space use the lined pages at the end of this booklet. The question numbers must be clearly shown.
- Answer **all** the questions.
- Where appropriate, your answer should be supported with working. Marks might be given for using a correct method, even if your answer is wrong.

**INFORMATION**

- The total mark for this paper is **70**.
- The marks for each question are shown in brackets [ ].
- Quality of extended response will be assessed in questions marked with an asterisk (\*).
- This document has **20** pages.

**ADVICE**

- Read each question carefully before you start your answer.

Answer **all** the questions.

- 1 (a) A student was observing onion epithelial cells using a light microscope. They photographed these cells and the image obtained is shown in Fig. 1.1. The student then made a drawing of a few cells from this image. The drawing is shown in Fig. 1.2.

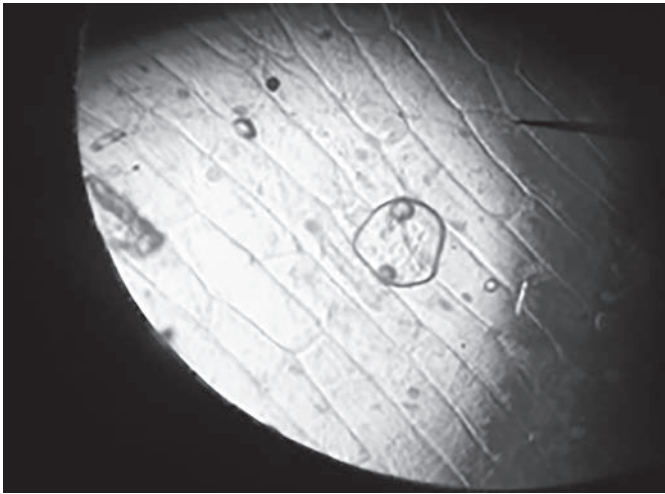

**Fig. 1.1**

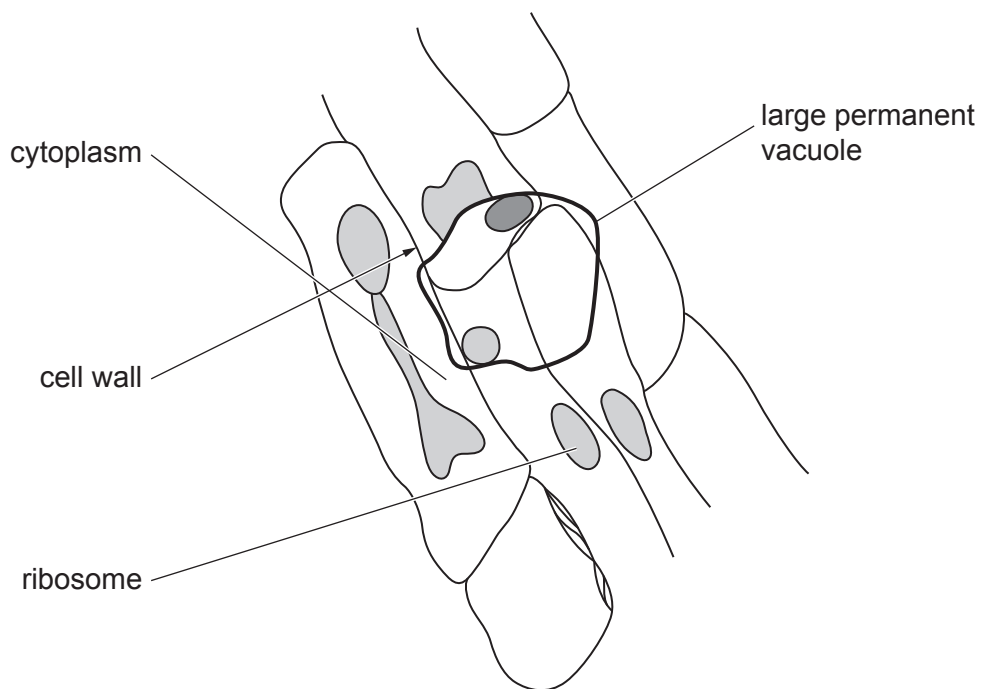

**Fig. 1.2**

The teacher stated that two of the labels on the drawing Fig. 1.2 were incorrect, and also that it was a poor quality biological drawing.

(i) Identify **one** incorrect label and explain your answer.

Incorrect label .....

Explanation .....

.....

.....

[3]

(ii) State **three** changes, other than to the labels, to Fig. 1.2 that the student would need to make to improve the biological drawing.

1 .....

.....

2 .....

.....

3 .....

.....

[3]

(b) Both a transmission electron microscope (TEM) and a scanning electron microscope (SEM) can be used to view the same cell. However, the images formed will be different.

Compare the resolutions of these microscopes **and** the images formed by them.

.....

.....

.....

.....

.....

.....

.....

.....

.....

..... [4]

(c) (i) A student wrote the following passage about cells:

'Erythrocytes and neutrophils are formed in the spleen. One of the places ciliated epithelial cells are found is in blood vessels. Sperm cells are the male gametes and contain the haploid number of chromosomes. The cell wall of the guard cell is thicker on the side furthest away from the stoma, so the cell does not change shape symmetrically as its volume changes. Root hair cells increase the surface area for absorption of water and mineral ions from the soil.'

Identify **and** correct the errors in the passage.

Error 1 .....

Correction .....

.....

Error 2 .....

Correction .....

.....

Error 3 .....

Correction .....

.....

**[3]**

(ii) A man with a body mass of 73 kg was admitted to hospital with an infection. His neutrophil production was measured at approximately 3804 billion cells in a 24h period.

When healthy, the man was producing approximately 1.6 billion neutrophils  $\text{kg}^{-1} \text{h}^{-1}$ .

Calculate the percentage increase in neutrophil production due to the infection.

percentage increase = ..... % **[2]**



- 2 (a) Mucus is composed of water, carbohydrates, proteins and triglycerides.

Mucus is secreted by goblet cells.

Below is a diagram of a goblet cell as seen under an electron microscope.

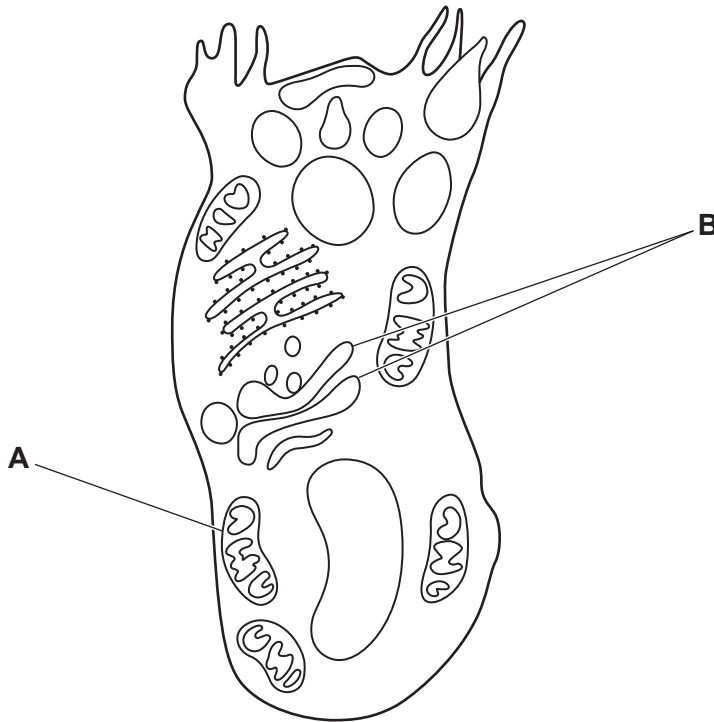

- (i) Suggest why goblet cells have large numbers of the cellular component labelled **A**.

.....  
..... [1]

- (ii) Suggest how the role of the cellular component labelled **B** is relevant to the function of the goblet cell.

.....  
.....  
.....  
.....  
..... [2]

(b) (i) Mucus is present in goblet cells as condensed granules.

Some studies reveal that when secreted, the mucus expands to 500 times its volume in 20 ms.

40 cm<sup>3</sup> of mucus is held in condensed granules.

Calculate the volume of mucus in these granules **one** second after secretion, assuming a constant rate of expansion.

volume of mucus = ..... cm<sup>3</sup> [2]

(ii) Sjogren's syndrome is a rare condition that can reduce the production of mucus.

Suggest how the upper respiratory tract of a person with Sjogren's syndrome might be affected.

.....  
.....  
..... [1]

- (c) (i) A protein is made up of amino acids which are joined by chemical bonds.

Below is an incomplete diagram of one of these bonds.

Complete the diagram of the molecular structure of these two amino acids to show how they are joined together **and** name the bond you have drawn.

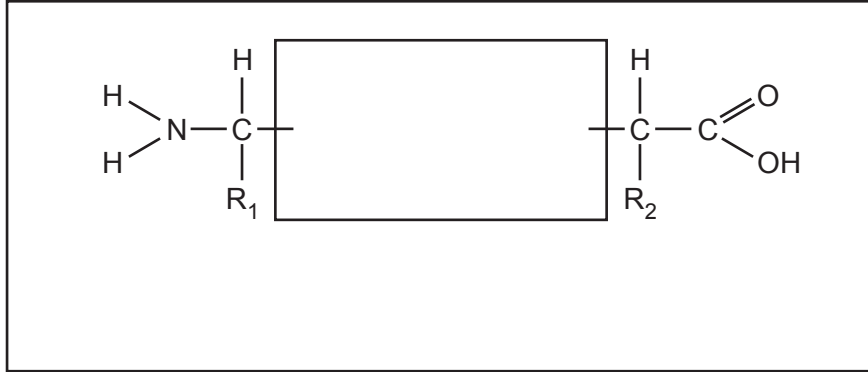

Name of bond .....

[2]

- (ii) The process of esterification leads to the formation of ester bonds during the production of triglycerides.

Describe what is meant by the term esterification.

.....

.....

.....

.....

.....

..... [2]



(d) Sjogren's syndrome is an autoimmune condition.

- Family members of Sjogren's syndrome sufferers can often have other autoimmune diseases such as Lupus
  - Lupus affects approximately 1 in 1350 of the world's population
  - In 2018 the world population was estimated at  $7.7 \times 10^9$
  - The world population is estimated to increase by 1.11% a year
  - Around 60% of Lupus sufferers are photosensitive, meaning their symptoms can be triggered by going out in direct sunlight.
- (i) Using the information provided, calculate how many of the world's Lupus sufferers by the end of 2019 would be photosensitive.

number of photosensitive Lupus sufferers = ..... [2]

(ii) Lupus symptoms include pain in joints, inflammation, fatigue, fever and a skin rash.

Suggest what component of sunlight causes photosensitivity and which symptom is likely to be more common in photosensitive sufferers.

Component of sunlight .....

Symptom ..... [1]

(iii) Explain what is meant by an autoimmune disease **and** suggest why members of the same family can be sufferers of autoimmune diseases.

.....  
.....  
.....  
.....  
..... [2]

3 (a) Different types of pathogen cause communicable diseases in plants and animals.

Complete the table by adding the correct type of pathogen for each communicable disease.

The first one has been done for you.

Type of Pathogen	Communicable Disease
bacterium	tuberculosis (TB)
.....	potato late blight
.....	malaria

[2]

(b) People with malarial pathogens generate distinct odours on their skin. Scientists in Gambia have carried out trials using dogs that have been trained to identify malarial infection in children. The dogs sniff clothing worn by the children. The dogs were trained to sniff each sample and to freeze if they detected malaria, or move on if they did not.

- In one trial the dogs sniffed the socks from 175 children
- 17% of these children had malaria
- The dogs correctly identified 70% of children with malarial infection by sniffing their socks.

(i) Calculate how many of the children who were suffering from malaria were correctly identified by the dogs.

number of children = ..... [2]

(ii) Suggest **one** limitation of this trial.

.....  
 ..... [1]

- (c) Some people are immune to malaria. They produce a specific type of antibody. One way in which antibodies defend the body is by acting as agglutinins.

Outline the action of agglutinins.

.....

.....

.....

.....

.....

..... [2]

**Turn over for the next question**

- 4 A program has been developed for vaccinations against the influenza virus and is updated yearly. It is recommended that the vaccination be given to adults aged 65 years and over and those under 65 years with 'at-risk' health conditions. However, not all the people in these groups take up the offer of the influenza vaccination.

The data in Fig. 4.1 show the number of influenza cases in four different environments within a single city during three consecutive winter periods from 2015–2018.

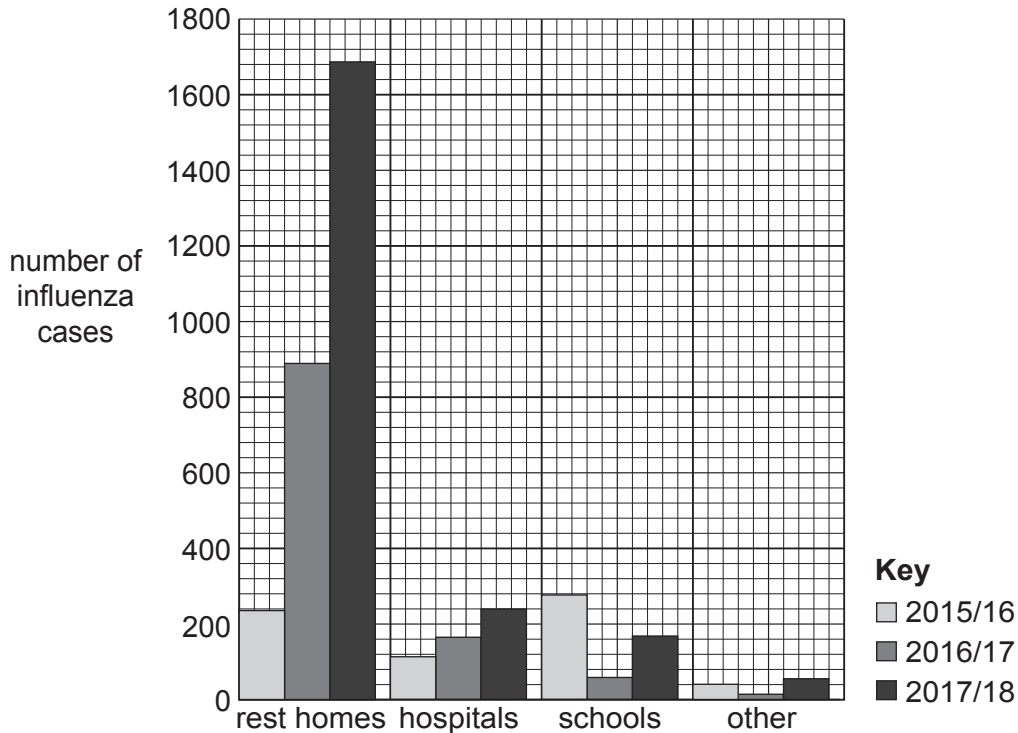

Fig. 4.1

The data in Fig. 4.2 show the percentage uptake of the influenza vaccine in four different environments in the same city during three consecutive winter periods from 2015–2018.

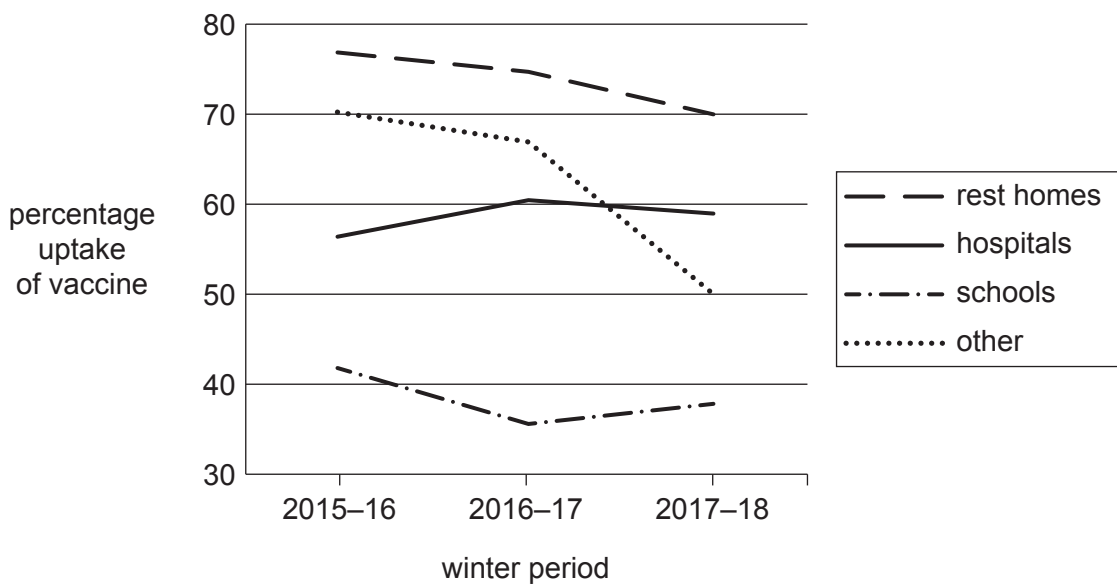

Fig. 4.2



(b) Complete the following sequence to outline how a vaccine gives an individual immunity. The first two steps have been completed for you.

**Step 1:** A vaccine is produced that is a safe form of an antigen.

**Step 2:** A small amount of vaccine is injected into blood of the individual to be vaccinated.

**Step 3:** .....

.....

.....

**Step 4:** .....

.....

.....

**Step 5:** .....

.....

.....

[3]

(c) Measles is a highly contagious viral infection.

In October 2018, an outbreak of the disease on the island of Madagascar resulted in more than 50 000 cases of measles. Fewer than 50% of the population was vaccinated when the outbreak began. The government of Madagascar hoped to bring the epidemic under control by vaccinating 90% of the population.

Discuss why this response was likely to bring the measles outbreak on Madagascar under control.

.....

.....

.....

.....

.....

[2]

- 5 (a) A group of students set up the apparatus shown below to test the effect of temperature on the rate of diffusion of glucose molecules in model cells.

They determined the concentration of glucose in the distilled water by taking samples at 30s intervals. They carried out the Benedict's test on each sample and used a calibrated colorimeter to determine the absorbance of each sample. Previously they had produced a calibration curve of colorimeter readings against glucose concentration. They used the calibration curve to determine the glucose concentrations of their samples.

They carried out the investigation at three different temperatures.

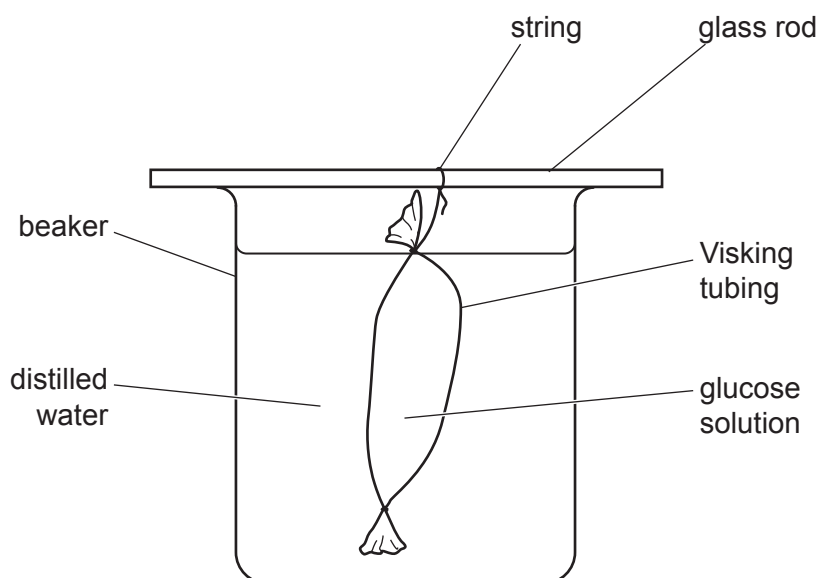

A table of the results from the students' investigation is shown below.

Temperature of water bath (°C)	Concentration of glucose found in the distilled water samples taken at 30s intervals ( $\text{mmol dm}^{-3}$ )				
	0s	30s	60s	90s	120s
10	0.00	0.33	0.65	0.98	1.30
20	0.00	0.80	3.21	2.40	3.20
30	0.00	1.23	2.45	3.68	4.90

- (i) Suggest an improvement to the method that would allow the students to obtain more precise results.

.....  
 ..... [1]

- (ii) State **one** variable that should have been controlled during this experiment.

..... [1]

(b) (i) Before the students began their investigation they made a hypothesis.

State the hypothesis the students would have made **and** state the scientific process that supports your choice.

Hypothesis .....

.....

Scientific process .....

.....

[2]

(ii) Justify whether the results from the investigation support your hypothesis given in part (b)(i).

.....

.....

.....

.....

[2]

(c) Describe how you would use the same equipment to test if the thickness of the exchange surface affects the diffusion rate.

.....

.....

.....

.....

[2]



6 (a) The cubes shown in Fig. 6.1 represent two different sized animals.

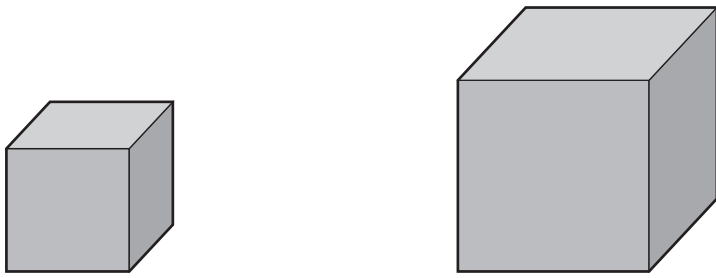

Small multicellular animal  
Volume =  $8 \text{ cm}^3$   
Surface area =  $24 \text{ cm}^2$

Large multicellular animal  
Volume =  $64 \text{ cm}^3$   
Surface area =  $96 \text{ cm}^2$

**Fig. 6.1**

Explain how Fig. 6.1 demonstrates the need for larger multicellular animals to have specialised exchange surfaces.

.....

.....

.....

.....

.....

..... [2]



- (c) In mammals the lungs act as the gas exchange system. Various components of this system work together to ensure gas exchange is efficient. Two such components are cartilage and elastic fibres.

State the roles of these two components in mammalian gas exchange.

Cartilage .....

.....

.....

Elastic fibres .....

.....

.....

[2]

**END OF QUESTION PAPER**

**ADDITIONAL ANSWER SPACE**

If additional space is required, you should use the following lined page(s). The question number(s) must be clearly shown in the margin(s).

A large rectangular area with a solid vertical line on the left side and horizontal dotted lines across the rest of the page, providing space for writing answers.



**Copyright Information**

OCR is committed to seeking permission to reproduce all third-party content that it uses in its assessment materials. OCR has attempted to identify and contact all copyright holders whose work is used in this paper. To avoid the issue of disclosure of answer-related information to candidates, all copyright acknowledgements are reproduced in the OCR Copyright Acknowledgements Booklet. This is produced for each series of examinations and is freely available to download from our public website ([www.ocr.org.uk](http://www.ocr.org.uk)) after the live examination series. If OCR has unwittingly failed to correctly acknowledge or clear any third-party content in this assessment material, OCR will be happy to correct its mistake at the earliest possible opportunity.

For queries or further information please contact The OCR Copyright Team, The Triangle Building, Shaftesbury Road, Cambridge CB2 8EA.

OCR is part of the Cambridge Assessment Group; Cambridge Assessment is the brand name of University of Cambridge Local Examinations Syndicate (UCLES), which is itself a department of the University of Cambridge.

## Friday 16 October 2020 – Morning

### AS Level Biology A

#### H020/02 Depth in biology

**Time allowed: 1 hour 30 minutes**



**You must have:**

- the Insert (inside this document)

**You can use:**

- a scientific or graphical calculator
- a ruler (cm/mm)



Please write clearly in black ink. **Do not write in the barcodes.**

Centre number

--	--	--	--	--

Candidate number

--	--	--	--

First name(s) \_\_\_\_\_

Last name \_\_\_\_\_

### INSTRUCTIONS

- Use black ink. You can use an HB pencil, but only for graphs and diagrams.
- Write your answer to each question in the space provided. If you need extra space use the lined pages at the end of this booklet. The question numbers must be clearly shown.
- Answer **all** the questions.
- Where appropriate, your answer should be supported with working. Marks might be given for using a correct method, even if your answer is wrong.

### INFORMATION

- The total mark for this paper is **70**.
- The marks for each question are shown in brackets [ ].
- Quality of extended response will be assessed in questions marked with an asterisk (\*).
- This document has **20** pages.

### ADVICE

- Read each question carefully before you start your answer.

Answer **all** the questions.

- 1 (a) A student was observing onion epithelial cells using a light microscope. They photographed these cells and the image obtained is shown in Fig. 1.1. The student then made a drawing of a few cells from this image. The drawing is shown in Fig. 1.2.

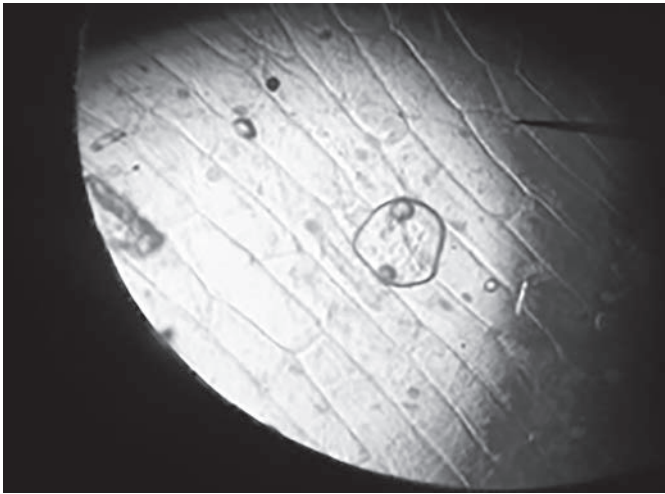

Fig. 1.1

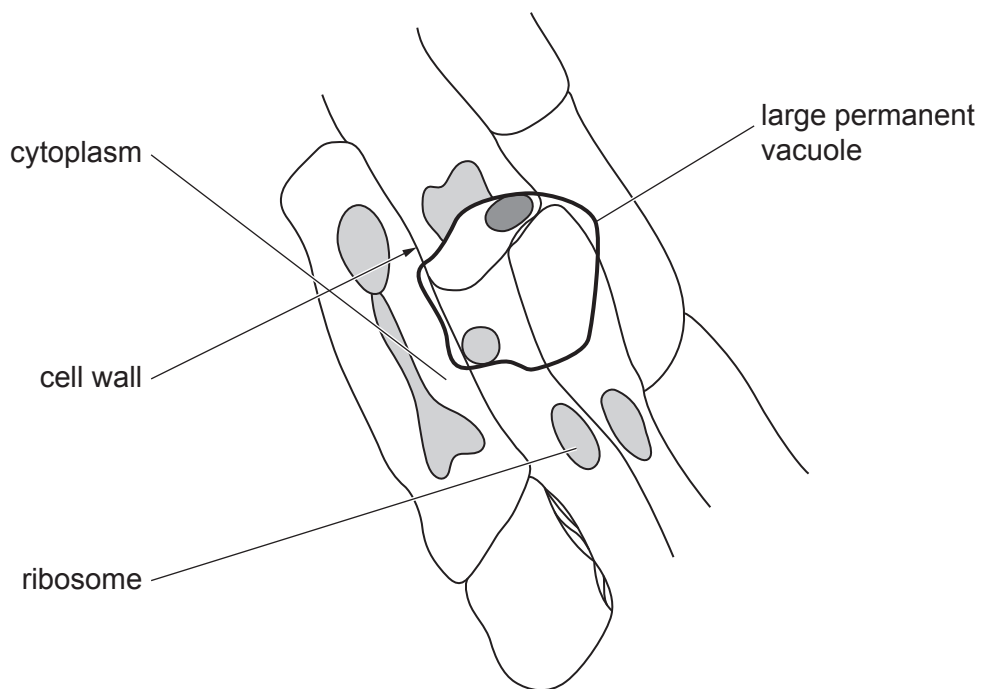

Fig. 1.2

The teacher stated that two of the labels on the drawing Fig. 1.2 were incorrect, and also that it was a poor quality biological drawing.

(i) Identify **one** incorrect label and explain your answer.

Incorrect label .....

Explanation .....

.....

.....

[3]

(ii) State **three** changes, other than to the labels, to Fig. 1.2 that the student would need to make to improve the biological drawing.

1 .....

.....

2 .....

.....

3 .....

.....

[3]

(b) Both a transmission electron microscope (TEM) and a scanning electron microscope (SEM) can be used to view the same cell. However, the images formed will be different.

Compare the resolutions of these microscopes **and** the images formed by them.

.....

.....

.....

.....

.....

.....

.....

.....

.....

..... [4]

(c) (i) A student wrote the following passage about cells:

'Erythrocytes and neutrophils are formed in the spleen. One of the places ciliated epithelial cells are found is in blood vessels. Sperm cells are the male gametes and contain the haploid number of chromosomes. The cell wall of the guard cell is thicker on the side furthest away from the stoma, so the cell does not change shape symmetrically as its volume changes. Root hair cells increase the surface area for absorption of water and mineral ions from the soil.'

Identify **and** correct the errors in the passage.

Error 1 .....

Correction .....

.....

Error 2 .....

Correction .....

.....

Error 3 .....

Correction .....

.....

**[3]**

(ii) A man with a body mass of 73 kg was admitted to hospital with an infection. His neutrophil production was measured at approximately 3804 billion cells in a 24h period.

When healthy, the man was producing approximately 1.6 billion neutrophils  $\text{kg}^{-1} \text{h}^{-1}$ .

Calculate the percentage increase in neutrophil production due to the infection.

percentage increase = ..... % **[2]**





2 (a) Mucus is composed of water, carbohydrates, proteins and triglycerides.

Mucus is secreted by goblet cells.

Below is a diagram of a goblet cell as seen under an electron microscope.

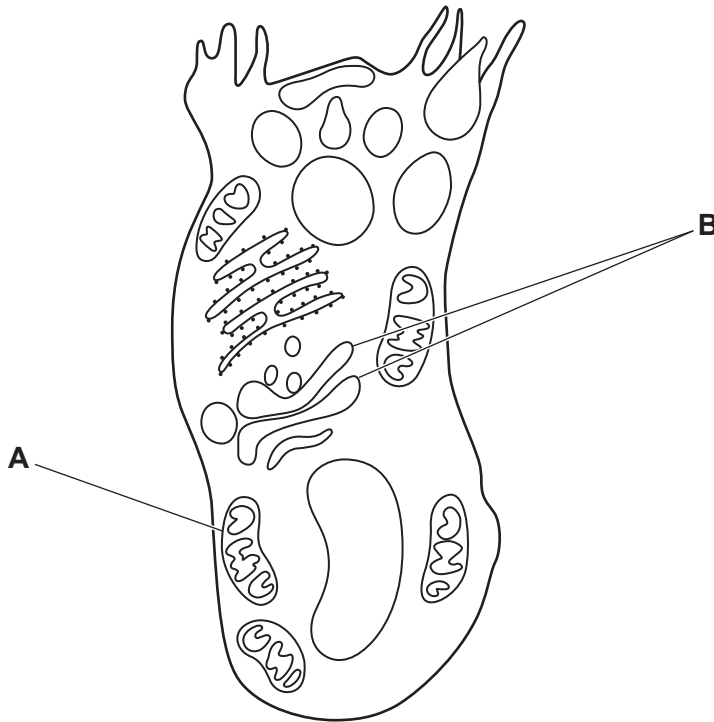

(i) Suggest why goblet cells have large numbers of the cellular component labelled **A**.

.....  
..... [1]

(ii) Suggest how the role of the cellular component labelled **B** is relevant to the function of the goblet cell.

.....  
.....  
.....  
.....  
..... [2]

(b) (i) Mucus is present in goblet cells as condensed granules.

Some studies reveal that when secreted, the mucus expands to 500 times its volume in 20 ms.

40 cm<sup>3</sup> of mucus is held in condensed granules.

Calculate the volume of mucus in these granules **one** second after secretion, assuming a constant rate of expansion.

volume of mucus = ..... cm<sup>3</sup> [2]

(ii) Sjogren's syndrome is a rare condition that can reduce the production of mucus.

Suggest how the upper respiratory tract of a person with Sjogren's syndrome might be affected.

.....  
.....  
..... [1]

- (c) (i) A protein is made up of amino acids which are joined by chemical bonds.

Below is an incomplete diagram of one of these bonds.

Complete the diagram of the molecular structure of these two amino acids to show how they are joined together **and** name the bond you have drawn.

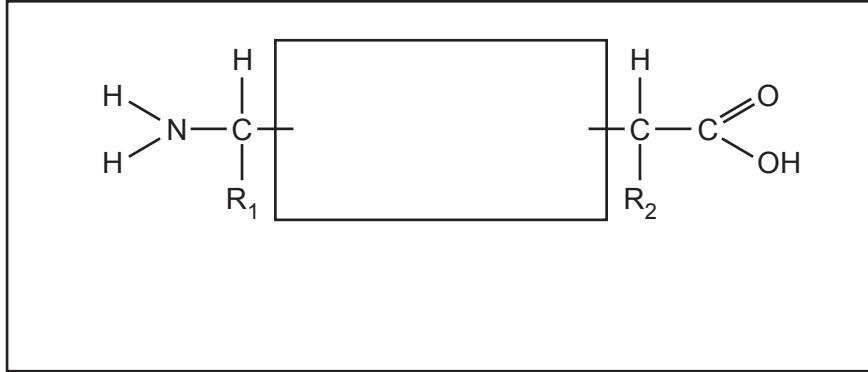

Name of bond .....

[2]

- (ii) The process of esterification leads to the formation of ester bonds during the production of triglycerides.

Describe what is meant by the term esterification.

.....

.....

.....

.....

.....

..... [2]

(d) Sjogren's syndrome is an autoimmune condition.

- Family members of Sjogren's syndrome sufferers can often have other autoimmune diseases such as Lupus
  - Lupus affects approximately 1 in 1350 of the world's population
  - In 2018 the world population was estimated at  $7.7 \times 10^9$
  - The world population is estimated to increase by 1.11% a year
  - Around 60% of Lupus sufferers are photosensitive, meaning their symptoms can be triggered by going out in direct sunlight.
- (i) Using the information provided, calculate how many of the world's Lupus sufferers by the end of 2019 would be photosensitive.

number of photosensitive Lupus sufferers = ..... [2]

(ii) Lupus symptoms include pain in joints, inflammation, fatigue, fever and a skin rash.

Suggest what component of sunlight causes photosensitivity and which symptom is likely to be more common in photosensitive sufferers.

Component of sunlight .....

Symptom ..... [1]

(iii) Explain what is meant by an autoimmune disease **and** suggest why members of the same family can be sufferers of autoimmune diseases.

.....  
.....  
.....  
.....  
..... [2]

3 (a) Different types of pathogen cause communicable diseases in plants and animals.

Complete the table by adding the correct type of pathogen for each communicable disease.

The first one has been done for you.

Type of Pathogen	Communicable Disease
bacterium	tuberculosis (TB)
.....	potato late blight
.....	malaria

[2]

(b) People with malarial pathogens generate distinct odours on their skin. Scientists in Gambia have carried out trials using dogs that have been trained to identify malarial infection in children. The dogs sniff clothing worn by the children. The dogs were trained to sniff each sample and to freeze if they detected malaria, or move on if they did not.

- In one trial the dogs sniffed the socks from 175 children
- 17% of these children had malaria
- The dogs correctly identified 70% of children with malarial infection by sniffing their socks.

(i) Calculate how many of the children who were suffering from malaria were correctly identified by the dogs.

number of children = ..... [2]

(ii) Suggest **one** limitation of this trial.

.....  
 ..... [1]

- (c) Some people are immune to malaria. They produce a specific type of antibody. One way in which antibodies defend the body is by acting as agglutinins.

Outline the action of agglutinins.

.....

.....

.....

.....

.....

..... [2]

**Turn over for the next question**

- 4 A program has been developed for vaccinations against the influenza virus and is updated yearly. It is recommended that the vaccination be given to adults aged 65 years and over and those under 65 years with 'at-risk' health conditions. However, not all the people in these groups take up the offer of the influenza vaccination.

The data in Fig. 4.1 show the number of influenza cases in four different environments within a single city during three consecutive winter periods from 2015–2018.

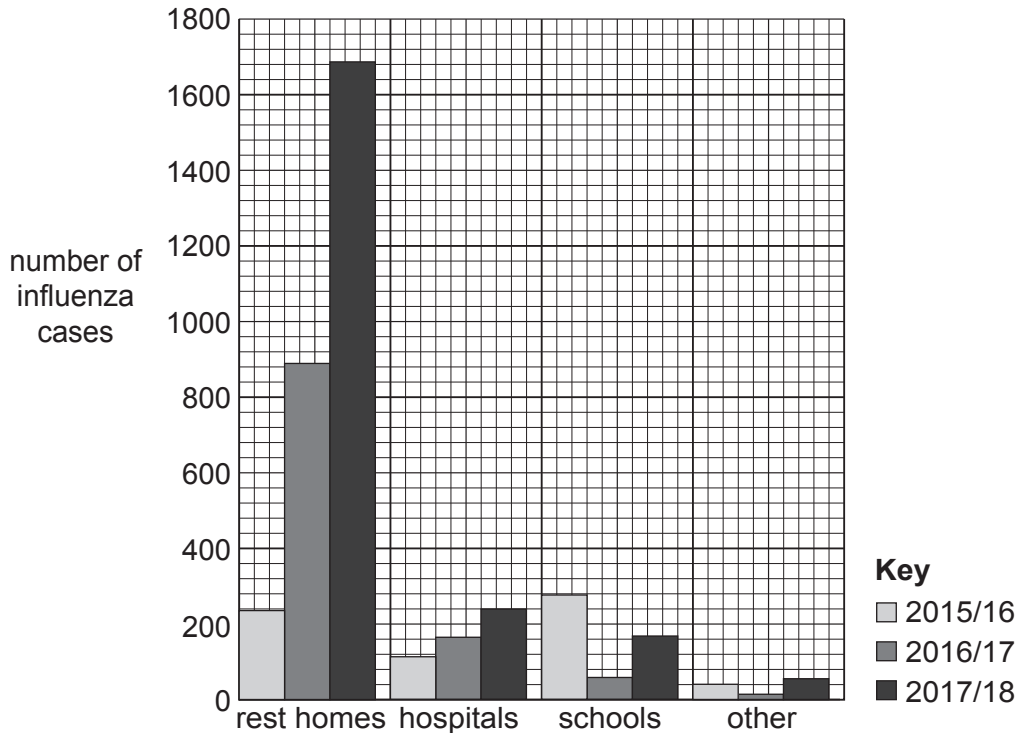

Fig. 4.1

The data in Fig. 4.2 show the percentage uptake of the influenza vaccine in four different environments in the same city during three consecutive winter periods from 2015–2018.

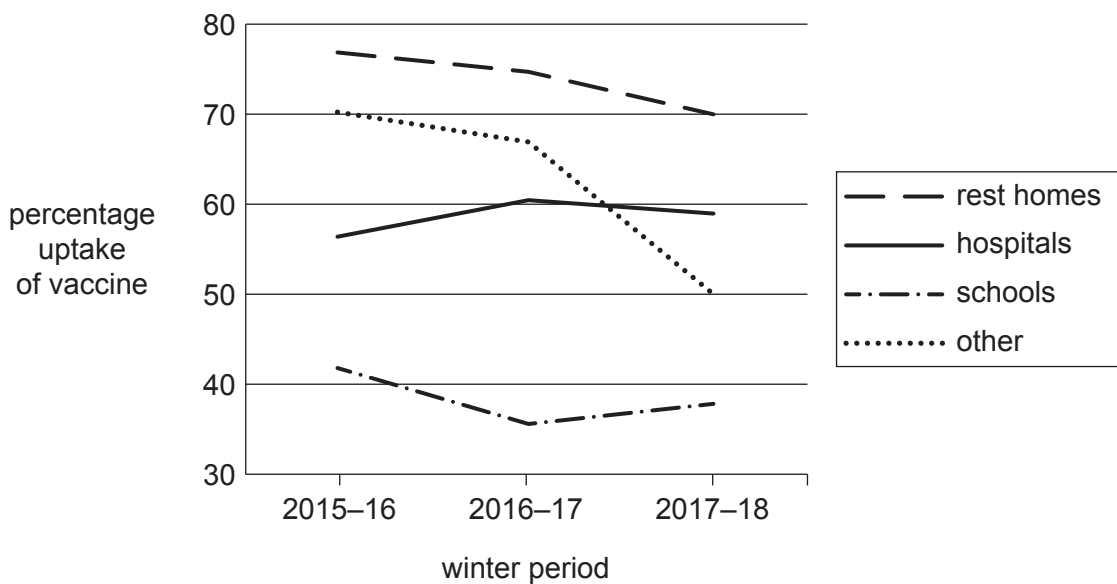

Fig. 4.2





(b) Complete the following sequence to outline how a vaccine gives an individual immunity. The first two steps have been completed for you.

**Step 1:** A vaccine is produced that is a safe form of an antigen.

**Step 2:** A small amount of vaccine is injected into blood of the individual to be vaccinated.

**Step 3:** .....

.....

.....

**Step 4:** .....

.....

.....

**Step 5:** .....

.....

.....

[3]

(c) Measles is a highly contagious viral infection.

In October 2018, an outbreak of the disease on the island of Madagascar resulted in more than 50 000 cases of measles. Fewer than 50% of the population was vaccinated when the outbreak began. The government of Madagascar hoped to bring the epidemic under control by vaccinating 90% of the population.

Discuss why this response was likely to bring the measles outbreak on Madagascar under control.

.....

.....

.....

.....

.....

[2]

- 5 (a) A group of students set up the apparatus shown below to test the effect of temperature on the rate of diffusion of glucose molecules in model cells.

They determined the concentration of glucose in the distilled water by taking samples at 30s intervals. They carried out the Benedict's test on each sample and used a calibrated colorimeter to determine the absorbance of each sample. Previously they had produced a calibration curve of colorimeter readings against glucose concentration. They used the calibration curve to determine the glucose concentrations of their samples.

They carried out the investigation at three different temperatures.

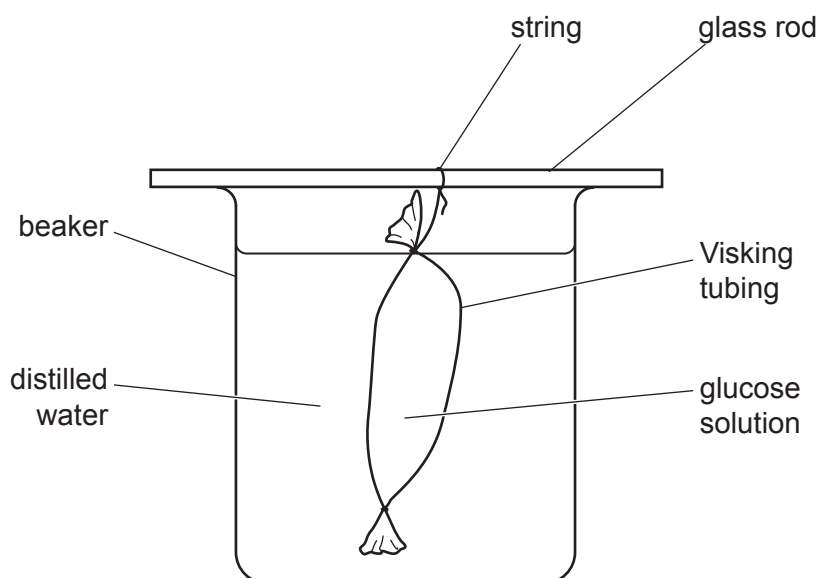

A table of the results from the students' investigation is shown below.

Temperature of water bath (°C)	Concentration of glucose found in the distilled water samples taken at 30s intervals ( $\text{mmol dm}^{-3}$ )				
	0s	30s	60s	90s	120s
10	0.00	0.33	0.65	0.98	1.30
20	0.00	0.80	3.21	2.40	3.20
30	0.00	1.23	2.45	3.68	4.90

- (i) Suggest an improvement to the method that would allow the students to obtain more precise results.

.....  
 ..... [1]

- (ii) State **one** variable that should have been controlled during this experiment.

..... [1]

(b) (i) Before the students began their investigation they made a hypothesis.

State the hypothesis the students would have made **and** state the scientific process that supports your choice.

Hypothesis .....

.....

Scientific process .....

.....

[2]

(ii) Justify whether the results from the investigation support your hypothesis given in part (b)(i).

.....

.....

.....

.....

[2]

(c) Describe how you would use the same equipment to test if the thickness of the exchange surface affects the diffusion rate.

.....

.....

.....

.....

[2]

6 (a) The cubes shown in Fig. 6.1 represent two different sized animals.

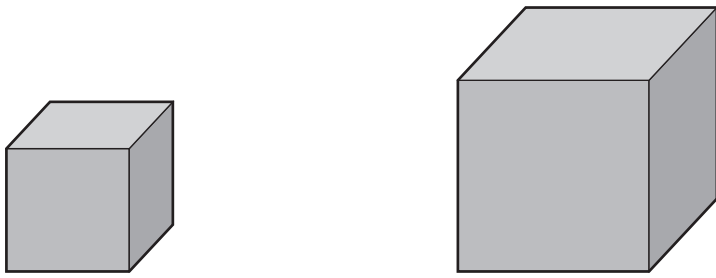

Small multicellular animal  
Volume =  $8 \text{ cm}^3$   
Surface area =  $24 \text{ cm}^2$

Large multicellular animal  
Volume =  $64 \text{ cm}^3$   
Surface area =  $96 \text{ cm}^2$

**Fig. 6.1**

Explain how Fig. 6.1 demonstrates the need for larger multicellular animals to have specialised exchange surfaces.

.....

.....

.....

.....

.....

..... [2]



- (c) In mammals the lungs act as the gas exchange system. Various components of this system work together to ensure gas exchange is efficient. Two such components are cartilage and elastic fibres.

State the roles of these two components in mammalian gas exchange.

Cartilage .....

.....

.....

Elastic fibres .....

.....

.....

[2]

**END OF QUESTION PAPER**

**ADDITIONAL ANSWER SPACE**

If additional space is required, you should use the following lined page(s). The question number(s) must be clearly shown in the margin(s).

A large rectangular area with a solid vertical line on the left side and horizontal dotted lines across the rest of the page, providing space for writing answers.



Oxford Cambridge and RSA

**Copyright Information**

OCR is committed to seeking permission to reproduce all third-party content that it uses in its assessment materials. OCR has attempted to identify and contact all copyright holders whose work is used in this paper. To avoid the issue of disclosure of answer-related information to candidates, all copyright acknowledgements are reproduced in the OCR Copyright Acknowledgements Booklet. This is produced for each series of examinations and is freely available to download from our public website ([www.ocr.org.uk](http://www.ocr.org.uk)) after the live examination series.

If OCR has unwittingly failed to correctly acknowledge or clear any third-party content in this assessment material, OCR will be happy to correct its mistake at the earliest possible opportunity.

For queries or further information please contact The OCR Copyright Team, The Triangle Building, Shaftesbury Road, Cambridge CB2 8EA.

OCR is part of the Cambridge Assessment Group; Cambridge Assessment is the brand name of University of Cambridge Local Examinations Syndicate (UCLES), which is itself a department of the University of Cambridge.