

GCE

Chemistry A

H432/03: Unified chemistry

Advanced GCE

Mark Scheme for Autumn 2021

OCR (Oxford Cambridge and RSA) is a leading UK awarding body, providing a wide range of qualifications to meet the needs of candidates of all ages and abilities. OCR qualifications include AS/A Levels, Diplomas, GCSEs, Cambridge Nationals, Cambridge Technicals, Functional Skills, Key Skills, Entry Level qualifications, NVQs and vocational qualifications in areas such as IT, business, languages, teaching/training, administration and secretarial skills.

It is also responsible for developing new specifications to meet national requirements and the needs of students and teachers. OCR is a not-for-profit organisation; any surplus made is invested back into the establishment to help towards the development of qualifications and support, which keep pace with the changing needs of today's society.















This mark scheme is published as an aid to teachers and students, to indicate the requirements of the examination. It shows the basis on which marks were awarded by examiners. It does not indicate the details of the discussions which took place at an examiners' meeting before marking commenced.

All examiners are instructed that alternative correct answers and unexpected approaches in candidates' scripts must be given marks that fairly reflect the relevant knowledge and skills demonstrated.

Mark schemes should be read in conjunction with the published question papers and the report on the examination.

© OCR 2021

1. Annotations

Annotation	Meaning
	Correct response
	Incorrect response
	Omission mark
	Benefit of doubt given
	Contradiction
	Rounding error
	Error in number of significant figures
	Error carried forward
	Level 1
	Level 2
	Level 3
	Benefit of doubt not given
	Noted but no credit given
	Ignore

2. Abbreviations, annotations and conventions used in the detailed Mark Scheme (to include abbreviations and subject-specific conventions).

Annotation	Meaning
DO NOT ALLOW	Answers which are not worthy of credit
IGNORE	Statements which are irrelevant
ALLOW	Answers that can be accepted
()	Words which are not essential to gain credit
—	Underlined words must be present in answer to score a mark
ECF	Error carried forward
AW	Alternative wording
ORA	Or reverse argument

Question	Answer	Marks	AO element	Guidance
1 (a)	<p>FIRST CHECK THE ANSWER ON ANSWER LINE If answer = 20 award 2 marks</p> <p>-----</p> $n(\text{CO}_2) = \frac{110}{44} \text{ OR } 2.5 \text{ (mol)}$ <p>AND</p> $n(\text{O}_2) = \frac{120}{32} \text{ OR } 3.75 \text{ (mol) } \checkmark$ $p(\text{CO}_2) = \frac{2.5}{6.25} \times 50.0 \text{ OR } 0.4 \times 50.0 = 20(.0) \text{ (atm) } \checkmark$	2	AO1.2 × 2	<p>ALLOW ECF from incorrect $\Sigma (n(\text{CO}_2) + n(\text{O}_2))$ ONLY</p>
1 (b)	<p>FIRST CHECK THE ANSWER ON ANSWER LINES If $[\text{PCl}_3] = [\text{Cl}_2] = 0.02(00)$ award 2 marks</p> <p>-----</p> $K_c = \frac{[\text{PCl}_3][\text{Cl}_2]}{[\text{PCl}_5]} \text{ OR with number(s), e.g. } K_c = \frac{[\text{PCl}_3][\text{Cl}_2]}{0.05(00)} \checkmark$ $[\text{PCl}_3] = [\text{Cl}_2] = \sqrt{(K_c \times [\text{PCl}_5])}$ $= \sqrt{(8.00 \times 10^{-3} \times 0.0500)}$ $= \sqrt{(4.00 \times 10^{-4})}$ $= \mathbf{2.00 \times 10^{-2}} \text{ (mol dm}^{-3}\text{) } \checkmark$	2	AO1.1 AO2.2	<p>Square brackets required</p> <p>-----</p> <p>Common errors</p> <p>2.00×10^{-4} from $K_c = \frac{[\text{PCl}_3][\text{Cl}_2]}{[\text{PCl}_5]}$ 1 mark $\neq 2$ instead of $\sqrt{\quad}$</p> <p>2.5 from $K_c = \frac{[\text{PCl}_5]}{[\text{PCl}_3][\text{Cl}_2]}$ 1 mark Inverse K_c expression</p>

Question	Answer	Marks	AO element	Guidance
	<p>Electronegativity and boiling point Boiling point/Energy increases with increased electronegativity (difference) ✓</p> <p>Type of intermolecular force HF AND NH₃ have hydrogen bonding AND CH₄ has London forces/induced (dipole-)dipole interactions ✓</p> <p>Comparison between strength of intermolecular forces HF has stronger hydrogen bonding than NH₃ OR hydrogen bonding is stronger than London forces ✓</p>	3	AO1.1 AO1.2 AO2.1	<p>ANNOTATE WITH TICKS AND CROSSES ALLOW ORA throughout</p> <p>-----</p> <p>ORA</p> <p>IGNORE permanent dipole interactions IGNORE IDID IGNORE HF and NH₃ are polar/CH₄ is non-polar</p> <p>IGNORE strength of ionic and covalent bonds</p>
(d)	<p>A: Ca₃N₂ (formula required) ✓</p> <p>B: NH₃ OR ammonia ✓</p> <p>C: Ca(OH)₂ OR calcium hydroxide ✓</p> <p>Equation: Ca₃N₂ + 6H₂O → 2NH₃ + 3Ca(OH)₂ ✓</p>	4	AO1.1 AO2.7 ×2 AO2.6	<p>IGNORE working</p> <p>If B and C labels are the wrong way round OR missing, award 1/2 for B and C labels, i.e. for B Ca(OH)₂ C NH₃ 1/2 marks</p> <p>ALLOW CaO₂H₂</p> <p>ALLOW multiples for equation</p> <p>IF C = CaO, ALLOW ECF for: Ca₃N₂ + 3H₂O → 2NH₃ + 3CaO</p>

Question	Answer	Marks	AO element	Guidance
(e)	<p> $2\text{CH}_3\text{CH}(\text{OH})\text{COOH} + \text{Na}_2\text{CO}_3 \rightarrow$ $2\text{CH}_3\text{CH}(\text{OH})\text{COONa} + \text{CO}_2 +$ H_2O </p> <p> CO_2 and H_2O OR $\text{CH}_3\text{CH}(\text{OH})\text{COONa}$ as product(s) ✓ </p> <p>Balanced equation correct ✓</p> <p> $3\text{CH}_3\text{CH}(\text{OH})\text{COOH} + \text{Al} \rightarrow (\text{CH}_3\text{CH}(\text{OH})\text{COO})_3\text{Al} + 1\frac{1}{2} \text{H}_2$ </p> <p> H_2 OR $(\text{CH}_3\text{CH}(\text{OH})\text{COO})_3\text{Al}$ as product ✓ </p> <p>Balanced equation correct ✓</p>	4	AO2.6 ×4	<p>ALLOW multiples IGNORE state symbols</p> <p>ALLOW ions shown separately</p> <p>For CO_2 AND H_2O, ALLOW H_2CO_3</p> <p>ALLOW ...COONa^+ (i.e. one of charges missing)</p> <p>ALLOW ...$(\text{COO})_3\text{Al}^{3+}$ (i.e. one of charges missing)</p>

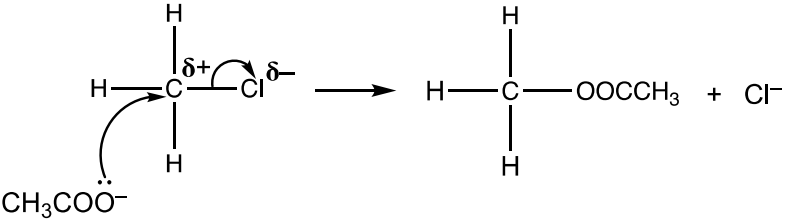
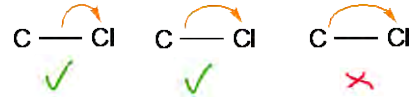
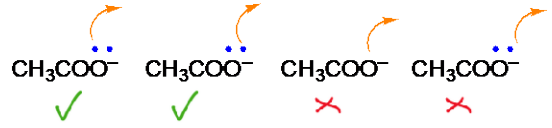
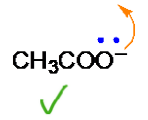
Question	Answer	Marks	AO element	Guidance
(f)	<p>Mechanism:</p>  <p>NOTE: Can be any C-X bond, e.g. C-Cl, C-Br, C-I but must be consistent.</p> <p>Curly arrow on C-X Dipole shown on C-X bond of CH₃X, C^{δ+} and X^{δ-} AND curly arrow from C-X bond to X atom ✓</p> <p>Curly arrow from CH₃COO⁻ Curly arrow from CH₃COO⁻ to C atom of C-X bond ✓</p> <hr/> <p>Products Correct organic product AND X⁻ ✓</p>	3	AO2.5 AO1.2 AO2.5	<p>ANNOTATE ANSWER TICKS AND CROSSES</p> <p>-----</p> <p>NOTE: Curly arrows can be straight, snake-like, etc. but NOT double headed or half headed arrows</p> <p>1st curly arrow must start from, OR be traced back to, any part of C-Cl bond and go to Cl</p>  <p>2nd curly arrow must</p> <ul style="list-style-type: none"> go to the C of C-Cl <p>AND</p> <ul style="list-style-type: none"> start from, OR be traced back to any point across width of lone pair on O of CH₃COO⁻  <ul style="list-style-type: none"> OR start from 'l' on O of CH₃COO⁻ ion  <div style="border: 1px solid black; padding: 5px; display: inline-block;"> <p>(Lone pair NOT needed if curly arrow from O⁻)</p> </div> <hr/> <p>If CH₃COOH used instead of CH₃COO⁻, ALLOW X⁻ OR HX as 2nd product</p>

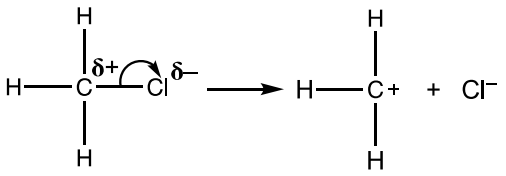
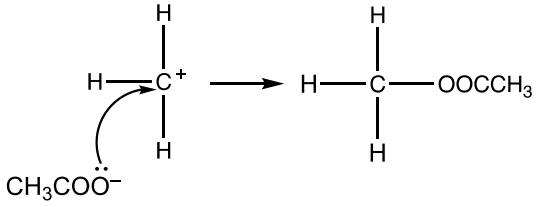
Question	Answer	Marks	AO element	Guidance
				<p>ALLOW S_N1 mechanism</p> <p>First mark Dipole shown on C–Cl bond, C^{δ+} and Cl^{δ-}, AND curly arrow from C–Cl bond to Cl atom ✓</p>  <p>Second mark Correct carbocation AND curly arrow from CH₃COO⁻ to carbocation</p>  <p>Curly arrow must be from lone pair on O of CH₃COO⁻ OR from minus on O of CH₃COO⁻ ion (no need to show lone pair if curly came from – charge) ✓</p> <p>Third mark Correct organic product AND Cl⁻ ✓</p>

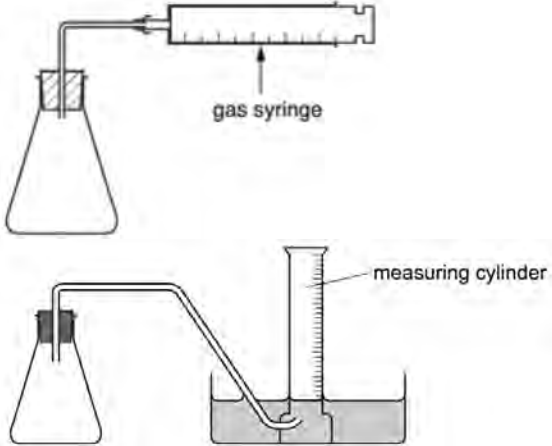
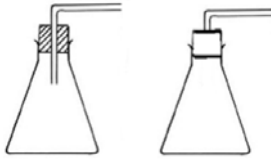
Question	Answer	Marks	AO element	Guidance
2 (a)	<p>Closed system that would work (<i>Labels not required</i>) Reaction apparatus with tube/side arm AND gas collection apparatus AND closed system ✓</p> <p>Labels Reaction apparatus, e.g.: Conical flask, Buchner flask/conical flask with side arm, test-tube, boiling tube. AND Gas collection apparatus: (gas) syringe OR gas collection over water with labelled measuring cylinder / burette ✓</p> 	2	AO3.3 × 2	<p>ALLOW small gaps provided there is an attempt to show closed system</p> <p>DO NOT ALLOW delivery tube below reaction mixture</p> <p>For reaction apparatus,</p> <ul style="list-style-type: none"> • DO NOT ALLOW flask, volumetric flask, beaker, measuring cylinder • Delivery tube, bung does NOT need a label <p>ALLOW labels for diagram without closed system (e.g. bung missing), i.e. 2nd mark but not 1st mark</p> <p>ALLOW any of these diagrams.</p>  <p>ALLOW a single line for the tube</p> <p>IGNORE Sealed end of delivery tube</p> <p>IGNORE size of syringe/measuring cylinder/burette</p>

Question	Answer	Marks	AO element	Guidance
(c)	The gas volume would be larger (than at RTP) ✓ Ratio H ₂ : Eu would be larger ✓	2	AO3.4 ×2	IGNORE effect of rate, e.g. rate increases IGNORE gas equation should be used to find $n(\text{H}_2)$ ALLOW Equation 3 linked to H ₂ : Eu > 1
(d)	<p>Qual Precipitates have different molar masses OR Precipitates have different formulae ✓</p> <p>Quant Equation 2 forms precipitate with $M = 186$ OR with formula Eu(OH)₂</p> <p>OR Equation 2 forms 1.86 g precipitate</p> <p>OR Molar mass M of precipitate = $\frac{\text{mass of precipitate}}{\text{moles precipitate}}$ OR $\frac{\text{mass of precipitate}}{\text{moles Eu}}$ OR $\frac{\text{mass of precipitate}}{0.01}$ ✓</p>	2	AO3.4 ×2	<p>ALLOW precipitates are EuOH, Eu(OH)₂ Eu(OH)₃ OR precipitates have different number of OH⁻ ions</p> <p>ALLOW Moles OH⁻ = $\frac{\text{mass of precipitate} - \text{mass of Eu}}{\text{molar mass of OH}^-}$ OR Moles OH⁻ = $\frac{\text{mass of precipitate} - 1.52}{17}$</p>

Question	Answer	Marks	AO element	Guidance
3 (a)	$n(\text{Ba}(\text{OH})_2) = 0.150 \times \frac{250}{1000}$ OR 0.0375 (mol) ✓ Mass $\text{Ba}(\text{OH})_2 = 0.0375 \times 171.3 = 6.42375$ (g) ✓ Dissolve solid in (distilled) water (less than 250 cm ³) in beaker ✓ Transfer (solution) to volumetric flask AND Transfer washings (from beaker) to flask ✓ Make up to mark/up to 250 cm ³ with (distilled) water AND Invert flask (several times to ensure mixing) ✓	5	AO2.4 ×2 AO1.2 ×3	ALLOW ECF from incorrect $n(\text{Ba}(\text{OH})_2)$ ALLOW 6.42 up to 6.42375 correctly rounded 6.42 g subsumes 1st mark ALLOW conical flask for beaker ALLOW graduated flask DO NOT ALLOW round-bottom or conical flask
(b)	$n(\text{Ba}(\text{OH})_2) = 0.150 \times \frac{23.50}{1000}$ $= 3.525 \times 10^{-3}$ (mol) ✓ $n(\text{D})$ in 25.0 cm ³ = $2 \times 3.525 \times 10^{-3}$ $= 7.05 \times 10^{-3}$ (mol) ✓ $n(\text{D})$ in 100 cm ³ = $7.05 \times 10^{-3} \times \frac{100}{25.0}$ $= 0.0282$ (mol) ✓ Molar mass (D) = $\frac{3.215}{0.0282} = 114$ (g mol ⁻¹) ✓ Formula: = C ₅ H ₉ COOH OR C _n H _{2n-1} : $M(\text{C}_5\text{H}_9) = 114 - 45 = 69$ ✓ <i>If not stated, could be credited from structure</i>	7	AO2.8 ×4 AO3.2 ×1	Use ECF throughout Intermediate values for working to at least 3 SF . TAKE CARE as value written down may be truncated value stored in calculator. Depending on rounding, either can be credited. <hr/> ALLOW Mass D in 25.0 cm ³ = $\frac{3.215}{4} = 0.80375$ g Molar mass (D) = $\frac{0.80375}{7.05 \times 10^{-3}} = 114$

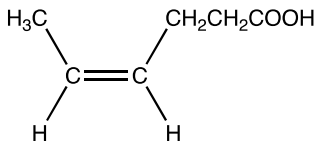
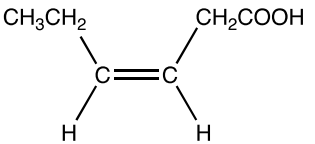
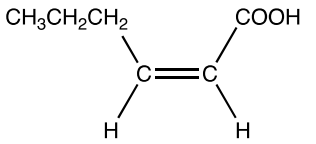
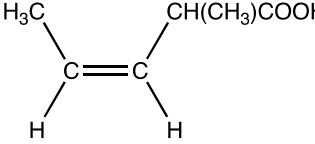
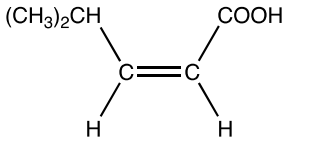
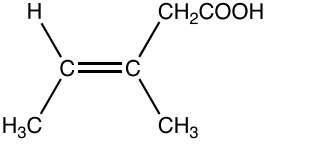
Question	Answer	Marks	AO element	Guidance
	<p>cis stereoisomers. The drawn stereoisomers must have</p> <ul style="list-style-type: none"> Different groups attached to each C atom of C=C Each C of C=C has the same group on the same side <p>Any 2 <i>cis</i> isomers ✓✓ <i>Many possibilities, e.g.</i></p> <div style="display: flex; justify-content: space-around;"> <div style="text-align: center;">  </div> <div style="text-align: center;">  </div> </div> <div style="display: flex; justify-content: space-around; margin-top: 20px;"> <div style="text-align: center;">  </div> <div style="text-align: center;">  </div> </div> <div style="display: flex; justify-content: space-around; margin-top: 20px;"> <div style="text-align: center;">  </div> <div style="text-align: center;">  </div> </div> <p>ALLOW correct structural, with 'cis' part displayed OR skeletal OR displayed formula OR mixture of above as long as non-ambiguous</p> <p>ALLOW side chains as molecular formula, e.g. C₃H₇ for (CH₃)₂CH OR CH₃CH₂CH₂ e.g. C₃H₅O₂ for CH₂CH₂COOH</p> <p>IGNORE poor connectivity to all groups</p>		AO3.2 ×2	<p>COMMON ERRORS: <i>Up to Molar mass = 114 (1st 4 marks)</i> <i>M = 456 → 3/4 marks (mol in 100 cm³ omitted)</i> $M = \frac{3.215}{7.05 \times 10^{-3}} = 456$</p> <p><i>M = 228 → 3/4 marks (No × 2 for n(D))</i> $3.525 \times 10^{-3} \times \frac{100}{25.0} = 0.0141$ $M = \frac{3.215}{0.0141} = 228$</p> <p><i>M = 100.8 → 3/4 marks</i> <i>23.50 instead of 25.00 and scaling by × $\frac{100}{23.50}$</i> $25.0 \times \frac{0.150}{1000} = 3.75 \times 10^{-3} \times$ $\rightarrow 2 \times 3.75 \times 10^{-3} = 7.5 \times 10^{-3} \checkmark$ $\rightarrow 7.5 \times 10^{-3} \times \frac{100}{23.50} = 0.0319 \checkmark$ $\rightarrow \frac{3.215}{0.0319} \rightarrow 100.8 \checkmark$</p> <p>THEN ALLOW ECF for carboxylic acid closest to calculated <i>M</i>(alkyl group) but must be C_nH_{2n-1} e.g. For <i>M</i>(alkyl) = 100, ALLOW C₄H₇ (55) For <i>M</i>(alkyl) = 411, ALLOW C₂₉H₅₇ (405) OR C₃₀H₅₉ (419)</p> <p>THEN judge <i>cis</i> isomers with closest match</p> <p>ALLOW 1 mark for 2 <i>trans</i> isomers shown instead of 2 <i>cis</i> isomers ECF for Same error made twice.</p>

Question		Answer	Marks	AO element	Guidance
4	(a)	(Large) excess of pent-1-ene OR There is a (large) excess ✓	1	AO3.1	ALLOW pent-1-ene concentration is (much) greater OR pent-1-ene has a high concentration
	(b)	<p><i>Please refer to the marking instructions on page 6 of this mark scheme for guidance on how to mark this question.</i></p> <p>Level 3 (5–6 marks) Obtains a comprehensive conclusion to determine initial rate AND order AND rate constant k</p> <p><i>There is a well-developed line of reasoning which is clear and logically structured. The information presented is relevant and substantiated.</i></p> <p>Level 2 (3–4 marks) Obtains a sound, but not comprehensive conclusion, to determine initial rate AND order OR order AND rate constant k OR initial rate AND rate constant k</p> <p><i>There is a line of reasoning presented with some structure. The information presented is relevant and supported by some evidence.</i></p> <p>Level 1 (1–2 marks) Obtains a simple conclusion to determine initial rate OR order</p> <p><i>There is an attempt at a logical structure with a line of reasoning. The information is in the most part relevant.</i></p> <p>0 marks No response or no response worthy of credit.</p>	6	AO3.1 ×4 AO3.2 ×2	<p><i>Indicative scientific points may include:</i></p> <p>Initial rate</p> <ul style="list-style-type: none"> Evidence of tangent on graph drawn to line at $t = 0$ s AND gradient determined in range $4.5 - 6.5 \times 10^{-6}$ <i>initial rate</i> expressed as gradient value with units of $\text{mol dm}^{-3} \text{s}^{-1}$, e.g. <i>initial rate</i> = $5.5 \times 10^{-6} \text{ mol dm}^{-3} \text{ s}^{-1}$ <p>Reasoned order of I_2</p> <p>Half lives</p> <ul style="list-style-type: none"> Half life measured on graph OR within text OR stated in range 2500 ± 10 s Constant half life OR two stated half lives within ± 10 s AND conclusion that I_2 is 1st order <p>OR</p> <p>Comparison of rates from gradients</p> <ul style="list-style-type: none"> Rate measured as gradient at a concentration, c Rate measured at $c/2$ c halves and rate halves so order 1 <p>e.g. initial rate at $c = 0.02 = 5.5 \times 10^{-6} \text{ mol dm}^{-3} \text{ s}^{-1}$ rate at $c = 0.01 = 2.58 \times 10^{-6} \text{ mol dm}^{-3} \text{ s}^{-1}$</p>

Question		Answer	Marks	AO element	Guidance
					<p>Determination of k with units</p> <ul style="list-style-type: none"> Rate constant k clearly linked to initial rate OR half-life: $k = \frac{\text{rate}}{[I_2]}$ OR $k = \frac{\ln 2}{t_{1/2}}$ k determined correctly from measured initial rate or measured half life with units of s^{-1}, e.g. $k = \frac{5.5 \times 10^{-6}}{0.02} = 2.75 \times 10^{-4} s^{-1}$ from initial rate of $5.5 \times 10^{-6} \text{ mol dm}^{-3} s^{-1}$ OR from $t_{1/2}$ of 2500 s Typical range $2.25\text{--}3.25 \times 10^{-4}$
(c)	(i)	Reactants for 1st step: $\text{CH}_3\text{CH}_2\text{CH}_2\text{CH}=\text{CH}_2 + \text{I}_2$ ✓ 2 steps that add up to overall equation: $\text{CH}_2\text{CH}_2\text{CH}=\text{CH}_2 + \text{I}_2 \rightarrow \text{CH}_3\text{CH}_2\text{CH}_2\text{CHICH}_2\text{I}$ ✓ e.g. $\text{CH}_3\text{CH}_2\text{CH}_2\text{CH}=\text{CH}_2 + \text{I}_2 \rightarrow \text{CH}_3\text{CH}_2\text{CH}_2\text{CHICH}_2^+ + \text{I}^-$ $\text{CH}_3\text{CH}_2\text{CH}_2\text{CHICH}_2^+ + \text{I}^- \rightarrow \text{CH}_3\text{CH}_2\text{CH}_2\text{CHICH}_2\text{I}$	2	AO2.5 × 2	<p>ALLOW mechanism for electrophilic addition shown.</p> <p>IGNORE state symbols</p> <p>Must be based on slow step, i.e. 2nd mark dependent on correct slow step: $\text{CH}_3\text{CH}_2\text{CH}_2\text{CH}=\text{CH}_2 + \text{I}_2$</p> <p>IGNORE actual positioning of + charge</p> <p>ALLOW $\rightarrow \text{CH}_3\text{CH}_2\text{CH}_2\text{CHICH}_2 + \text{I}$ (no charge) $\text{CH}_3\text{CH}_2\text{CH}_2\text{CHICH}_2 + \text{I} \rightarrow$</p>
	(ii)	Repeat experiment with $[I_2]$ constant/kept the same OR use (large) excess of I_2 ✓ Monitor/measure/plot $[\text{CH}_3\text{CH}_2\text{CH}_2\text{CH}=\text{CH}_2]$ over time OR Monitor/measure how $[\text{CH}_3\text{CH}_2\text{CH}_2\text{CH}=\text{CH}_2]$ affects rate ✓	2	AO3.4 ×2	<p>ALLOW I_2 in (great) excess</p> <p>ALLOW initial rates approach of running several experiments with different concentrations of $\text{CH}_3\text{CH}_2\text{CH}_2\text{CH}=\text{CH}_2$ i.e. Measure initial rates for each experiment AND double concentration \rightarrow rate doubles</p>

Question			Answer	Marks	AO element	Guidance
5	(a)	(i)	<p>Reduction: $\text{Na}^+ + \text{e}^- \rightarrow \text{Na} \checkmark$</p> <p>Oxidation: $2\text{N}_3^- \rightarrow 3\text{N}_2 + 2\text{e}^- \checkmark$</p> <p>ALLOW 1 mark for 2 correct equations but wrong way round</p>	2	AO1.2	<p>ALLOW multiples e.g. $2\text{Na}^+ + 2\text{e}^- \rightarrow 2\text{Na}$</p> <p>IGNORE state symbols</p>
		(ii)	<p>FIRST CHECK ANSWER ON ANSWER LINE IF mass = 34.5 (g) AND working using ideal gas equation Award 5 marks for calculation</p> <p>-----</p> <p>Rearranging ideal gas equation</p> $n = \frac{pV}{RT} \checkmark$ <p>Unit conversion AND substitution into $n = \frac{pV}{RT}$:</p> <ul style="list-style-type: none"> $R = 8.314$ OR 8.31 $V = 16(.0) \times 10^{-3}$ T in K: 290 K e.g. $\frac{1.20 \times 10^5 \times 16.0 \times 10^{-3}}{8.314 \times 290} \checkmark$ <p>Calculation of n $n = 0.796$ (mol) \checkmark</p> <p>Calculation of mass $n(\text{NaN}_3) = \frac{2}{3} \times 0.796 = 0.531$ (mol) \checkmark</p> <p>mass $\text{NaN}_3 = 0.531 \times 65 = 34.5$ (g) \checkmark 3 SF required</p>	5	AO2.4 ×5	<p>TAKE CARE as value written down may be truncated value stored in calculator.</p> <p>IF $n = \frac{pV}{RT}$ is omitted, ALLOW when values are substituted into rearranged ideal gas equation.</p> <p>Calculator: 0.7963302448</p> <p>From unrounded 0.7963302448, $n(\text{NaN}_3) = 0.5308868299$</p> <p>mass = $0.5308868299 \times 65 = 34.50764394$ → 34.5 to 3 SF</p> <p>COMMON ERROR 51.7 OR 51.8 → 4 marks (2/3 omitted depending on intermediate rounding $0.796 \times 65 = 51.7$ OR 51.8 54.4 → 4 marks (<i>inverted gas equation</i>) $n = \frac{RT}{pV} \rightarrow 1.255760417 \rightarrow 0.8371736111$ → 54.4 (g) CARE with intermediate rounding</p> <p>81.6 OR 81.7 → 3 mks (<i>as above but no 2/3</i>)</p>

Question		Answer	Marks	AO element	Guidance
(b)	(i)	<p>FIRST CHECK THE ANSWER ON ANSWER LINE If answer = 2.75 award 2 marks</p> <hr style="border-top: 1px dashed blue;"/> <p>$[H^+]^2 = K_a \times [HN_3] = 2.51 \times 10^{-5} \times 0.125$ $[H^+] = \sqrt{(K_a \times [HN_3])}$</p> <p>$[H^+]^2 = 2.51 \times 10^{-5} \times 0.125$ OR $[H^+] = \sqrt{(2.51 \times 10^{-5} \times 0.125)}$ OR $[H^+] = 1.77 \dots \times 10^{-3} \text{ (mol dm}^{-3}\text{)} \checkmark$</p> <p>$pH = -\log 1.77 \dots \times 10^{-3} = 2.75 \text{ (Must be to 2DP)} \checkmark$</p>	2	AO2.2 ×2	<p>ALLOW ECF throughout</p> <p>IGNORE error with HN_3 shown as NH_3</p> <p>ALLOW pH mark by ECF ONLY if $2.51 \times 10^{-5} \times 0.125$ used AND $pH < 7$</p> <hr style="border-top: 1px dashed black;"/> <p>Common errors (Must be to 2 DP) $pH = 5.50 \rightarrow 1 \text{ mark (No square root)}$</p> <p>$[H^+] = 6.26 \times 10^{-4}$ from $\sqrt{(2.51 \times 10^{-5}) \times 0.125}$ $pH = 3.20 \rightarrow 1 \text{ mark}$</p> <p>$[H^+] = 8.87 \times 10^{-6}$ from $\sqrt{(0.125) \times 2.51 \times 10^{-5}}$ $pH = 5.05 \rightarrow 1 \text{ mark}$</p>
	(ii)	<ul style="list-style-type: none"> Correct equation \checkmark Correct acid–base pair labels for correct equation \checkmark <p>$HN_3 + H_2O \rightleftharpoons N_3^- + H_3O^+ \checkmark$</p> <p>A1 B2 B1 A2 \checkmark</p> <p>OR</p> <p>A2 B1 B2 A1</p>	2	AO1.2 ×2	<p>ALLOW 1 mark for one correct acid–base pair WITH correct labels</p> <p>e.g. H_2O H_3O^+</p> <p>WITH B1 A1</p> <p>OR B2 A2</p>

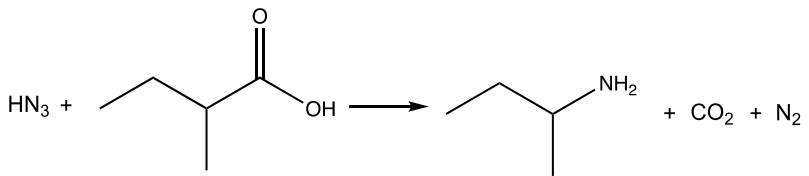
Question	Answer	Marks	AO element	Guidance
(iii)	<p>Structure of 2-methylbutanoic acid ✓</p> <p>Structure of organic product (primary amine) ✓</p> <p>CO₂ AND N₂ as products ✓</p> 	3	AO3.2 ×2 AO2.6	<p>ALLOW correct structural OR skeletal OR displayed formula OR mixture of the above as long as non-ambiguous</p> <p>Common error With NH₃, → CO₂ + H₂</p> <p>ALLOW ECF for equation using a different amine isomer of the organic product <i>e.g.</i> (CH₃)₂CHCH₂NH₂</p> <p>DO NOT ALLOW ECF from unbranched species, <i>e.g.</i> CH₃CH₂CH₂NH₂</p> <p>IGNORE HN₃ in equation, even if missing</p> <p>IGNORE poor connectivity to all groups</p>

Question	Answer	Marks	AO element	Guidance
(c)*	<p><i>Please refer to the marking instructions on page 6 of this mark scheme for guidance on how to mark this question.</i></p> <p>Level 3 (5–6 marks) Reaches a comprehensive conclusion to determine the correct formulae of almost all of E, F, G, H, I and J</p> <p><i>There is a well-developed line of reasoning which is clear and logically structured. The information presented is relevant and substantiated.</i></p> <p>Level 2 (3–4 marks) Reaches a sound conclusion to determine the correct formulae of at least half of E, F, G, H, I and J</p> <p><i>There is a line of reasoning presented with some structure. The information presented is relevant and supported by some evidence.</i></p> <p>Level 1 (1–2 marks) Reaches a simple conclusion to determine the correct formulae of some of E, F, G, H, I and J</p> <p><i>There is an attempt at a logical structure with a line of reasoning. The information is in the most part relevant.</i></p> <p>0 marks <i>No response or no response worthy of credit.</i></p>	6	AO3.1 x2 AO3.2 x4	<p>Indicative scientific points may include:</p> <p><u>Identify of E, F, G, H, I and J</u></p> <ul style="list-style-type: none"> • E Cu/copper • F: H₂O/water • G: N₂/nitrogen • H: CH₃COCl OR ClCH₂CHO OR C₂H₃OCl • I: CH₃CONH₂ OR H₂NCH₂CHO • J: NH₄Cl/ammonium chloride <p><u>Examples of reasoning</u></p> <p><u>Working</u></p> $n(\text{CuO}) = \frac{4.77}{(63.5 + 16)} = 0.06 \text{ (mol)}$ $M(\text{E}) = 3.81 \div 0.06 = 63.5$ $n(\text{G}) = \frac{480}{24000} = 0.02$ $M(\text{G}) = \frac{0.560}{0.02} = 28 \text{ (g mol}^{-1}\text{)}$ <p><u>Infrared spectrum</u> I contains</p> <ul style="list-style-type: none"> • C=O (~1700 cm⁻¹) • NH₂ (~3200–3400 cm⁻¹) <p><u>Equations</u></p> $3\text{CuO} + 2\text{NH}_3 \rightarrow 3\text{Cu} + 3\text{H}_2\text{O} + \text{N}_2$ <p>CH₃COCl + 2NH₃ → CH₃CONH₂ + NH₄Cl OR ClCH₂CHO + 2NH₃ → H₂NCH₂CHO + NH₄Cl</p>

OCR (Oxford Cambridge and RSA Examinations)
The Triangle Building
Shaftesbury Road
Cambridge
CB2 8EA

OCR Customer Contact Centre

Education and Learning

Telephone: 01223 553998

Facsimile: 01223 552627

Email: general.qualifications@ocr.org.uk

www.ocr.org.uk

For staff training purposes and as part of our quality assurance programme your call may be recorded or monitored